

VOLTAGE REGULATOR WITH ON/OFF SWITCH

FEATURES

- High Voltage Precision at $\pm 2.4\%$
- Active High On/Off Control
- Very Low Dropout Voltage 80 mV at 30 mA
- Very Low Noise
- Very Small SOT-23L or SOT-89-5 Surface Mount Packages
- Internal Thermal Shutdown
- Short Circuit Protection

APPLICATIONS

- Battery Powered Systems
- Cellular Telephones
- Pagers
- Personal Communications Equipment
- Portable Instrumentation
- Portable Consumer Equipment
- Radio Control Systems
- Toys
- Low Voltage Systems

DESCRIPTION

The TK112xxA is a low dropout linear regulator with a built-in electronic switch. The internal switch can be controlled by TTL or CMOS logic levels. The device is in the ON state when the control pin is pulled to a logic high level. An external capacitor can be connected to the noise bypass pin to lower the output noise level to 30 μ Vrms.

An internal PNP pass transistor is used to achieve a low dropout voltage of 70 mV (typ.) at 30 mA load current. The TK112xxA has a very low quiescent current of 180 μ A at no load and 1 mA with a 30 mA load. The standby current is typically 100 nA. The internal thermal shutdown circuitry limits the junction temperature to below 150 $^{\circ}$ C. The load current is internally monitored and the device will shutdown in the presence of a short circuit or overcurrent condition at the output.

The TK112xxA is available in either 6 pin SOT-23L or 5 pin SOT-89-5 surface mount packages.

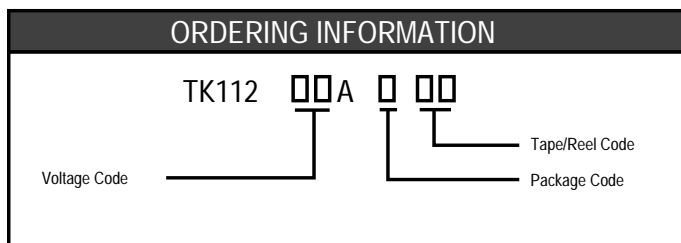
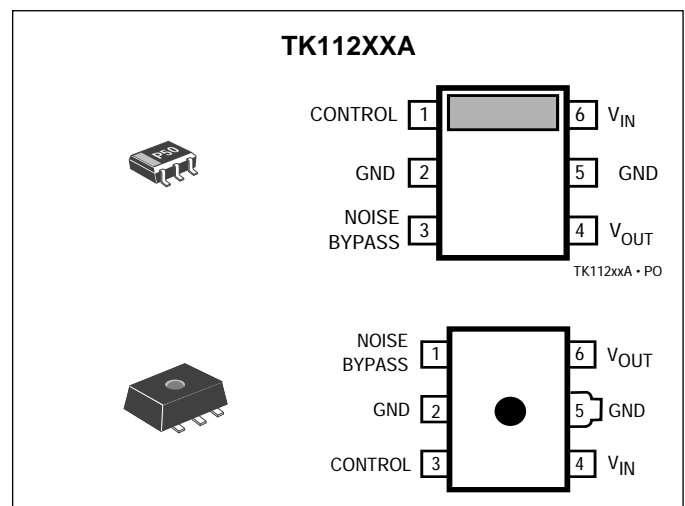

VOLTAGE CODE	PACKAGE CODE	TAPE/REEL CODE
20 = 2.0 V*	35 = 3.5 V*	BX : Bulk/Bag
21 = 2.1 V	36 = 3.6 V	TL : Tape Left (SOT-23L)
22 = 2.22 V*	38 = 3.8 V	TB : Tape Bottom (SOT-89-5)
25 = 2.5 V*	40 = 4.0 V*	
28 = 2.8 V*	42 = 4.2 V	
29 = 2.9 V	45 = 4.5 V*	
30 = 3.0 V*	48 = 4.8 V*	
31 = 3.1 V*	49 = 4.9 V	
33 = 3.3 V*	50 = 5.0 V*	
	55 = 5.5 V	

* Indicates voltage is available in a SOT-89-5 package.

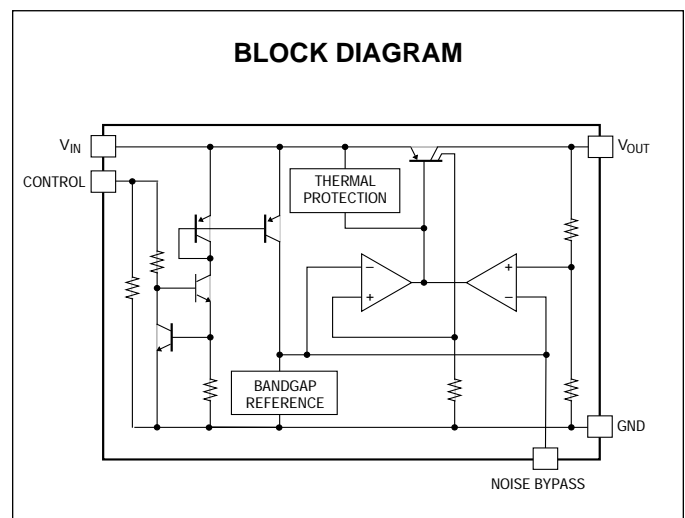

TK112xx A

ABSOLUTE MAXIMUM RATINGS

Supply Voltage	16 V	Operating Temperature Range	-30 to +80 °C
Power Dissipation SOT-23L (Note 1)	400 mW	Lead Soldering Temp. (3 sec.)	230 °C
Power Dissipation SOT-89-5 (Note 2)	800 mW	Junction Temperature	150 °C
Storage Temperature Range	-55 to +150 °C		

TK11220A ELECTRICAL CHARACTERISTICS

Test conditions: $T_A = 25\text{ °C}$, $V_{IN} = 3.0\text{ V}$, $C_P = 0.1\text{ }\mu\text{F}$, unless otherwise specified.

SYMBOL	PARAMETER	TEST CONDITIONS	MIN	TYP	MAX	UNITS
I_{IN}	Quiescent Current	$I_O = 0\text{ mA}$, Except I_{CONT}		170	350	μA
I_{STBY}	Standby Current	$V_{IN} = 8\text{ V}$, at output off			0.1	μA
V_O	Output Voltage	$I_O = 30\text{ mA}$	1.92	2.00	2.08	V
V_{DROP}	Dropout Voltage	$I_O = 60\text{ mA}$		0.16	0.26	V
		$I_O = 150\text{ mA}$		0.29	0.4	V
I_O	Output Current	$V_{OUT} = 1.7\text{ V}$	180	240		mA
I_{OR}	Recommended Output Current				150	mA
Line Reg	Line Regulation	$V_{IN} = 3\text{ V} \rightarrow 8\text{ V}$		3.0	20	mV
Load Reg	Load Regulation	$I_O = 5\text{ mA} \rightarrow 60\text{ mA}$ (Note 3)		10	50	mV
		$I_O = 5\text{ mA} \rightarrow 100\text{ mA}$		20	100	mV
		$I_O = 5\text{ mA} \rightarrow 150\text{ mA}$		30	160	mV
RR	Ripple Rejection	100 mV(rms), $I_O = 10\text{ mA}$		55		dB
$\Delta V_O / \Delta T_A$	Output Voltage Temperature Dependency	$I_O = 10\text{ mA}$ $-20\text{ °C} \leq T_A \leq +75\text{ °C}$		0.2		mV/°C
V_{NO}	Output Noise Voltage	10 Hz < f < 80 kHz, $I_O = 30\text{ mA}$		30		μV (rms)
V_{REF}	Noise Bypass Terminal Voltage			1.25		V
Control Terminal Specification						
I_{CONT}	Control Current	Output on, $V_{CONT} = 1.8\text{ V}$		12	30	μA
V_{CONT}	Control Voltage	Output on	1.8			V
		Output off			0.6	V
t_r	Output Rise Time	$I_O = 30\text{ mA}$, $V_{CONT} = 0\text{ V} \rightarrow 1.8\text{ V}$		0.3		ms

Note 1: Power dissipation is 400 mW when mounted as recommended. Derate at 3.2 mW/°C for $T_A > 25\text{ °C}$.

Note 2: Power dissipation is 800 mW when mounted as recommended. Derate at 6.4 mW/°C for $T_A > 25\text{ °C}$.

Note 3: This is a pulse measurement where T_J is constant. The output change due to temperature is not included.

TK11221A ELECTRICAL CHARACTERISTICSTest conditions: $T_A = 25\text{ }^\circ\text{C}$, $V_{IN} = 3.1\text{ V}$, $C_P = 0.1\text{ }\mu\text{F}$, unless otherwise specified.

SYMBOL	PARAMETER	TEST CONDITIONS	MIN	TYP	MAX	UNITS
I_{IN}	Quiescent Current	$I_O = 0\text{ mA}$, Except I_{CONT}		170	350	μA
I_{STBY}	Standby Current	$V_{IN} = 8\text{ V}$, at output off			0.1	μA
V_O	Output Voltage	$I_O = 30\text{ mA}$	2.02	2.10	2.18	V
V_{DROP}	Dropout Voltage	$I_O = 60\text{ mA}$		0.16	0.26	V
		$I_O = 150\text{ mA}$		0.29	0.4	V
I_O	Output Current	$V_{OUT} = 1.8\text{ V}$	180	240		mA
I_{OR}	Recommended Output Current				150	mA
Line Reg	Line Regulation	$V_{IN} = 3.1\text{ V} \rightarrow 8.1\text{ V}$		3.0	20	mV
Load Reg	Load Regulation	$I_O = 5\text{ mA} \rightarrow 60\text{ mA}$ (Note 1)		10	50	mV
		$I_O = 5\text{ mA} \rightarrow 100\text{ mA}$		20	100	mV
		$I_O = 5\text{ mA} \rightarrow 150\text{ mA}$		30	160	mV
RR	Ripple Rejection	100 mV(rms), $I_O = 10\text{ mA}$		55		dB
$\Delta V_O/\Delta T_A$	Output Voltage Temperature Dependency	$V_{IN} = 3.5\text{ V}$, $I_O = 10\text{ mA}$ $-20\text{ }^\circ\text{C} \leq T_A \leq +75\text{ }^\circ\text{C}$		0.2		mV/ $^\circ\text{C}$
V_{NO}	Output Noise Voltage	10 Hz < f < 80 kHz, $I_O = 30\text{ mA}$		30		μV (rms)
V_{REF}	Noise Bypass Terminal Voltage			1.25		V
Control Terminal Specification						
I_{CONT}	Control Current	Output on, $V_{CONT} = 1.8\text{ V}$		12	30	μA
V_{CONT}	Control Voltage	Output on	1.8			V
		Output off			0.6	V
t_r	Output Rise Time	$I_O = 30\text{ mA}$, $V_{CONT} = 0\text{ V} \rightarrow 1.8\text{ V}$		0.3		ms

Note 1: This is a pulse measurement where T_J is constant. The output change due to temperature is not included.

TK112xx A

TK11222A ELECTRICAL CHARACTERISTICS

Test conditions: $T_A = 25\text{ }^\circ\text{C}$, $V_{IN} = 3.22\text{ V}$, $C_P = 0.1\text{ }\mu\text{F}$, unless otherwise specified.

SYMBOL	PARAMETER	TEST CONDITIONS	MIN	TYP	MAX	UNITS
I_{IN}	Quiescent Current	$I_O = 0\text{ mA}$, Except I_{CONT}		170	350	μA
I_{STBY}	Standby Current	$V_{IN} = 8\text{ V}$, at output off			0.1	μA
V_O	Output Voltage	$I_O = 30\text{ mA}$	2.14	2.22	2.3	V
V_{DROP}	Dropout Voltage	$I_O = 60\text{ mA}$		0.16	0.26	V
		$I_O = 150\text{ mA}$		0.29	0.4	V
I_O	Output Current	$V_{OUT} = 1.92\text{ V}$	180	240		mA
I_{OR}	Recommended Output Current				150	mA
Line Reg	Line Regulation	$V_{IN} = 3.22\text{ V} \rightarrow 8.22\text{ V}$		3.0	20	mV
Load Reg	Load Regulation	$I_O = 5\text{ mA} \rightarrow 60\text{ mA}$ (Note 1)		10	50	mV
		$I_O = 5\text{ mA} \rightarrow 100\text{ mA}$		20	100	mV
		$I_O = 5\text{ mA} \rightarrow 150\text{ mA}$		30	160	mV
RR	Ripple Rejection	100 mV(rms), $I_O = 10\text{ mA}$		55		dB
$\Delta V_O / \Delta T_A$	Output Voltage Temperature Dependency	$V_{IN} = 3.72\text{ V}$, $I_O = 10\text{ mA}$ $-20\text{ }^\circ\text{C} \leq T_A \leq +75\text{ }^\circ\text{C}$		0.05		mV/ $^\circ\text{C}$
V_{NO}	Output Noise Voltage	10 Hz < f < 80 kHz, $I_O = 30\text{ mA}$		30		μV (rms)
V_{REF}	Noise Bypass Terminal Voltage			1.25		V
Control Terminal Specification						
I_{CONT}	Control Current	Output on, $V_{CONT} = 1.8\text{ V}$		12	30	μA
V_{CONT}	Control Voltage	Output on	1.8			V
		Output off			0.6	V
t_r	Output Rise Time	$I_O = 30\text{ mA}$, $V_{CONT} = 0\text{ V} \rightarrow 1.8\text{ V}$		0.3		ms

Note 1: This is a pulse measurement where T_J is constant. The output change due to temperature is not included.

TK11225A ELECTRICAL CHARACTERISTICSTest conditions: $T_A = 25\text{ }^\circ\text{C}$, $V_{IN} = 3.5\text{ V}$, $C_P = 0.1\text{ }\mu\text{F}$, unless otherwise specified.

SYMBOL	PARAMETER	TEST CONDITIONS	MIN	TYP	MAX	UNITS
I_{IN}	Quiescent Current	$I_O = 0\text{ mA}$, Except I_{CONT}		170	350	μA
I_{STBY}	Standby Current	$V_{IN} = 8\text{ V}$, at output off			0.1	μA
V_O	Output Voltage	$I_O = 30\text{ mA}$	2.42	2.50	2.58	V
V_{DROP}	Dropout Voltage	$I_O = 60\text{ mA}$		0.16	0.26	V
		$I_O = 150\text{ mA}$		0.29	0.4	V
I_O	Output Current	$V_{OUT} = 2.2\text{ V}$	180	240		mA
I_{OR}	Recommended Output Current				150	mA
Line Reg	Line Regulation	$V_{IN} = 3.5\text{ V} \rightarrow 8.5\text{ V}$ (Note 1)		3.0	20	mV
Load Reg	Load Regulation	$I_O = 5\text{ mA} \rightarrow 60\text{ mA}$		10	50	mV
		$I_O = 5\text{ mA} \rightarrow 100\text{ mA}$		20	100	mV
		$I_O = 5\text{ mA} \rightarrow 150\text{ mA}$		30	160	mV
RR	Ripple Rejection	100 mV(rms), $I_O = 10\text{ mA}$		55		dB
$\Delta V_O/\Delta T_A$	Output Voltage Temperature Dependency	$V_{IN} = 4.0\text{ V}$, $I_O = 10\text{ mA}$ $-20\text{ }^\circ\text{C} \leq T_A \leq +75\text{ }^\circ\text{C}$		0.05		mV/ $^\circ\text{C}$
V_{NO}	Output Noise Voltage	10 Hz < f < 80 kHz, $I_O = 30\text{ mA}$		30		μV (rms)
V_{REF}	Noise Bypass Terminal Voltage			1.25		V
Control Terminal Specification						
I_{CONT}	Control Current	Output on, $V_{CONT} = 1.8\text{ V}$		12	30	μA
V_{CONT}	Control Voltage	Output on	1.8			V
		Output off			0.6	V
t_r	Output Rise Time	$I_O = 30\text{ mA}$, $V_{CONT} = 0\text{ V} \rightarrow 1.8\text{ V}$		0.3		ms

Note 1: This is a pulse measurement where T_J is constant. The output change due to temperature is not included.

TK112xx A

TK11228A ELECTRICAL CHARACTERISTICS

Test conditions: $T_A = 25\text{ }^\circ\text{C}$, $V_{IN} = 3.8\text{ V}$, $C_P = 0.1\text{ }\mu\text{F}$, unless otherwise specified.

SYMBOL	PARAMETER	TEST CONDITIONS	MIN	TYP	MAX	UNITS
I_{IN}	Quiescent Current	$I_O = 0\text{ mA}$, Except I_{CONT}		170	350	μA
I_{STBY}	Standby Current	$V_{IN} = 8\text{ V}$, at output off			0.1	μA
V_O	Output Voltage	$I_O = 30\text{ mA}$	2.72	2.80	2.88	V
V_{DROP}	Dropout Voltage	$I_O = 60\text{ mA}$		0.16	0.26	V
		$I_O = 150\text{ mA}$		0.29	0.4	V
I_O	Output Current	$V_{OUT} = 2.5\text{ V}$	180	240		mA
I_{OR}	Recommended Output Current				150	mA
Line Reg	Line Regulation	$V_{IN} = 3.8\text{ V} \rightarrow 8.8\text{ V}$		3.0	20	mV
Load Reg	Load Regulation	$I_O = 5\text{ mA} \rightarrow 60\text{ mA}$ (Note 1)		10	50	mV
		$I_O = 5\text{ mA} \rightarrow 100\text{ mA}$		20	100	mV
		$I_O = 5\text{ mA} \rightarrow 150\text{ mA}$		30	160	mV
RR	Ripple Rejection	100 mV(rms), $I_O = 10\text{ mA}$		55		dB
$\Delta V_O / \Delta T_A$	Output Voltage Temperature Dependency	$V_{IN} = 4.3\text{ V}$, $I_O = 10\text{ mA}$ $-20\text{ }^\circ\text{C} \leq T_A \leq +75\text{ }^\circ\text{C}$		0.05		mV/ $^\circ\text{C}$
V_{NO}	Output Noise Voltage	10 Hz < f < 80 kHz, $I_O = 30\text{ mA}$		30		μV (rms)
V_{REF}	Noise Bypass Terminal Voltage			1.25		V
Control Terminal Specification						
I_{CONT}	Control Current	Output on, $V_{CONT} = 1.8\text{ V}$		12	30	μA
V_{CONT}	Control Voltage	Output on	1.8			V
		Output off			0.6	V
t_r	Output Rise Time	$I_O = 30\text{ mA}$, $V_{CONT} = 0\text{ V} \rightarrow 1.8\text{ V}$		0.3		ms

Note 1: This is a pulse measurement where T_J is constant. The output change due to temperature is not included.

TK11229A ELECTRICAL CHARACTERISTICSTest conditions: $T_A = 25\text{ }^\circ\text{C}$, $V_{IN} = 3.9\text{ V}$, $C_P = 0.1\text{ }\mu\text{F}$, unless otherwise specified.

SYMBOL	PARAMETER	TEST CONDITIONS	MIN	TYP	MAX	UNITS
I_{IN}	Quiescent Current	$I_O = 0\text{ mA}$, Except I_{CONT}		170	350	μA
I_{STBY}	Standby Current	$V_{IN} = 8\text{ V}$, at output off			0.1	μA
V_O	Output Voltage	$I_O = 30\text{ mA}$	2.82	2.90	2.98	V
V_{DROP}	Dropout Voltage	$I_O = 60\text{ mA}$		0.16	0.26	V
		$I_O = 150\text{ mA}$		0.29	0.4	V
I_O	Output Current	$V_{OUT} = 2.6\text{ V}$		240		mA
I_{OR}	Recommended Output Current				150	mA
Line Reg	Line Regulation	$V_{IN} = 3.9\text{ V} \rightarrow 8.9\text{ V}$		3.0	20	mV
Load Reg	Load Regulation	$I_O = 5\text{ mA} \rightarrow 60\text{ mA}$ (Note 1)		10	50	mV
		$I_O = 5\text{ mA} \rightarrow 100\text{ mA}$		20	100	mV
		$I_O = 5\text{ mA} \rightarrow 150\text{ mA}$		30	160	mV
RR	Ripple Rejection	100 mV(rms), $I_O = 10\text{ mA}$		55		dB
$\Delta V_O/\Delta T_A$	Output Voltage Temperature Dependency	$V_{IN} = 4.4\text{ V}$, $I_O = 10\text{ mA}$ $-20\text{ }^\circ\text{C} \leq T_A \leq +75\text{ }^\circ\text{C}$		0.05		mV/ $^\circ\text{C}$
V_{NO}	Output Noise Voltage	10 Hz < f < 80 kHz, $I_O = 30\text{ mA}$		30		μV (rms)
V_{REF}	Noise Bypass Terminal Voltage			1.25		V
Control Terminal Specification						
I_{CONT}	Control Current	Output on, $V_{CONT} = 1.8\text{ V}$		12	30	μA
V_{CONT}	Control Voltage	Output on	1.8			V
		Output off			0.6	V
t_r	Output Rise Time	$I_O = 30\text{ mA}$, $V_{CONT} = 0\text{ V} \rightarrow 1.8\text{ V}$		0.3		ms

Note 1: This is a pulse measurement where T_j is constant. The output change due to temperature is not included.

TK112xx A

TK11230A ELECTRICAL CHARACTERISTICS

Test conditions: $T_A = 25\text{ }^\circ\text{C}$, $V_{IN} = 4.0\text{ V}$, $C_P = 0.1\text{ }\mu\text{F}$, unless otherwise specified.

SYMBOL	PARAMETER	TEST CONDITIONS	MIN	TYP	MAX	UNITS
I_{IN}	Quiescent Current	$I_O = 0\text{ mA}$, Except I_{CONT}		170	350	μA
I_{STBY}	Standby Current	$V_{IN} = 8\text{ V}$, at output off			0.1	μA
V_O	Output Voltage	$I_O = 30\text{ mA}$	2.92	3.00	3.08	V
V_{DROP}	Dropout Voltage	$I_O = 60\text{ mA}$		0.16	0.26	V
		$I_O = 150\text{ mA}$		0.29	0.4	V
I_O	Output Current	$V_{OUT} = 2.7\text{ V}$	180	240		mA
I_{OR}	Recommended Output Current				150	mA
Line Reg	Line Regulation	$V_{IN} = 4\text{ V} \rightarrow 9\text{ V}$		3.0	20	mV
Load Reg	Load Regulation	$I_O = 5\text{ mA} \rightarrow 60\text{ mA}$ (Note 1)		10	50	mV
		$I_O = 5\text{ mA} \rightarrow 100\text{ mA}$		20	100	mV
		$I_O = 5\text{ mA} \rightarrow 150\text{ mA}$		30	160	mV
RR	Ripple Rejection	100 mV(rms), $I_O = 10\text{ mA}$		55		dB
$\Delta V_O/\Delta T_A$	Output Voltage Temperature Dependency	$V_{IN} = 4.5\text{ V}$, $I_O = 10\text{ mA}$ $-20\text{ }^\circ\text{C} \leq T_A \leq +75\text{ }^\circ\text{C}$		0.05		mV/ $^\circ\text{C}$
V_{NO}	Output Noise Voltage	10 Hz < f < 80 kHz, $I_O = 30\text{ mA}$		30		μV (rms)
V_{REF}	Noise Bypass Terminal Voltage			1.25		V
Control Terminal Specification						
I_{CONT}	Control Current	Output on, $V_{CONT} = 1.8\text{ V}$		12	30	μA
V_{CONT}	Control Voltage	Output on	1.8			V
		Output off			0.6	V
t_r	Output Rise Time	$I_O = 30\text{ mA}$, $V_{CONT} = 0\text{ V} \rightarrow 1.8\text{ V}$		0.3		ms

Note 1: This is a pulse measurement where T_J is constant. The output change due to temperature is not included.

TK11231A ELECTRICAL CHARACTERISTICSTest conditions: $T_A = 25\text{ }^\circ\text{C}$, $V_{IN} = 4.1\text{ V}$, $C_P = 0.1\text{ }\mu\text{F}$, unless otherwise specified.

SYMBOL	PARAMETER	TEST CONDITIONS	MIN	TYP	MAX	UNITS
I_{IN}	Quiescent Current	$I_O = 0\text{ mA}$, Except I_{CONT}		170	350	μA
I_{STBY}	Standby Current	$V_{IN} = 8\text{ V}$, at output off			0.1	μA
V_O	Output Voltage	$I_O = 30\text{ mA}$	3.02	3.10	3.18	V
V_{DROP}	Dropout Voltage	$I_O = 60\text{ mA}$		0.16	0.26	V
		$I_O = 150\text{ mA}$		0.29	0.4	V
I_O	Output Current	$V_{OUT} = 2.8\text{ V}$	180	240		mA
I_{OR}	Recommended Output Current				150	mA
Line Reg	Line Regulation	$V_{IN} = 4.1\text{ V} \rightarrow 9.1\text{ V}$		3.0	20	mV
Load Reg	Load Regulation	$I_O = 5\text{ mA} \rightarrow 60\text{ mA}$ (Note 1)		10	50	mV
		$I_O = 5\text{ mA} \rightarrow 100\text{ mA}$		20	100	mV
		$I_O = 5\text{ mA} \rightarrow 150\text{ mA}$		30	160	mV
RR	Ripple Rejection	100 mV(rms), $I_O = 10\text{ mA}$		55		dB
$\Delta V_O/\Delta T_A$	Output Voltage Temperature Dependency	$V_{IN} = 4.6\text{ V}$, $I_O = 10\text{ mA}$ $-20\text{ }^\circ\text{C} \leq T_A \leq +75\text{ }^\circ\text{C}$		0.05		mV/ $^\circ\text{C}$
V_{NO}	Output Noise Voltage	10 Hz < f < 80 kHz, $I_O = 30\text{ mA}$		30		μV (rms)
V_{REF}	Noise Bypass Terminal Voltage			1.25		V
Control Terminal Specification						
I_{CONT}	Control Current	Output on, $V_{CONT} = 1.8\text{ V}$		12	30	μA
V_{CONT}	Control Voltage	Output on	1.8			V
		Output off			0.6	V
t_r	Output Rise Time	$I_O = 30\text{ mA}$, $V_{CONT} = 0\text{ V} \rightarrow 1.8\text{ V}$		0.3		ms

Note 1: This is a pulse measurement where T_J is constant. The output change due to temperature is not included.

TK112xx A

TK11233A ELECTRICAL CHARACTERISTICS

Test conditions: $T_A = 25\text{ }^\circ\text{C}$, $V_{IN} = 4.3\text{ V}$, $C_P = 0.1\text{ }\mu\text{F}$, unless otherwise specified.

SYMBOL	PARAMETER	TEST CONDITIONS	MIN	TYP	MAX	UNITS
I_{IN}	Quiescent Current	$I_O = 0\text{ mA}$, Except I_{CONT}		170	350	μA
I_{STBY}	Standby Current	$V_{IN} = 8\text{ V}$, at output off			0.1	μA
V_O	Output Voltage	$I_O = 30\text{ mA}$	3.22	3.30	3.38	V
V_{DROP}	Dropout Voltage	$I_O = 60\text{ mA}$		0.16	0.26	V
		$I_O = 150\text{ mA}$		0.29	0.4	V
I_O	Output Current	$V_{OUT} = 3\text{ V}$	180	240		mA
I_{OR}	Recommended Output Current				150	mA
Line Reg	Line Regulation	$V_{IN} = 4.3\text{ V} \rightarrow 9.3\text{ V}$		3.0	20	mV
Load Reg	Load Regulation	$I_O = 5\text{ mA} \rightarrow 60\text{ mA}$ (Note 1)		10	50	mV
		$I_O = 5\text{ mA} \rightarrow 100\text{ mA}$		20	100	mV
		$I_O = 5\text{ mA} \rightarrow 150\text{ mA}$		30	160	mV
RR	Ripple Rejection	100 mV(rms), $I_O = 10\text{ mA}$		55		dB
$\Delta V_O / \Delta T_A$	Output Voltage Temperature Dependency	$V_{IN} = 4.8\text{ V}$, $I_O = 10\text{ mA}$ $-20\text{ }^\circ\text{C} \leq T_A \leq +75\text{ }^\circ\text{C}$		0.05		mV/ $^\circ\text{C}$
V_{NO}	Output Noise Voltage	10 Hz < f < 80 kHz, $I_O = 30\text{ mA}$		30		μV (rms)
V_{REF}	Noise Bypass Terminal Voltage			1.25		V
Control Terminal Specification						
I_{CONT}	Control Current	Output on, $V_{CONT} = 1.8\text{ V}$		12	30	μA
V_{CONT}	Control Voltage	Output on	1.8			V
		Output off			0.6	V
t_r	Output Rise Time	$I_O = 30\text{ mA}$, $V_{CONT} = 0\text{ V} \rightarrow 1.8\text{ V}$		0.3		ms

Note 1: This is a pulse measurement where T_J is constant. The output change due to temperature is not included.

TK11235A ELECTRICAL CHARACTERISTICSTest conditions: $T_A = 25\text{ }^\circ\text{C}$, $V_{IN} = 4.5\text{ V}$, $C_P = 0.1\text{ }\mu\text{F}$, unless otherwise specified.

SYMBOL	PARAMETER	TEST CONDITIONS	MIN	TYP	MAX	UNITS
I_{IN}	Quiescent Current	$I_O = 0\text{ mA}$, Except I_{CONT}		170	350	μA
I_{STBY}	Standby Current	$V_{IN} = 8\text{ V}$, at output off			0.1	μA
V_O	Output Voltage	$I_O = 30\text{ mA}$	3.42	3.50	3.58	V
V_{DROP}	Dropout Voltage	$I_O = 60\text{ mA}$		0.16	0.26	V
		$I_O = 150\text{ mA}$		0.29	0.4	V
I_O	Output Current	$V_{OUT} = 3.2\text{ V}$	180	240		mA
I_{OR}	Recommended Output Current				150	mA
Line Reg	Line Regulation	$V_{IN} = 4.5\text{ V} \rightarrow 9.5\text{ V}$		3.0	20	mV
Load Reg	Load Regulation	$I_O = 5\text{ mA} \rightarrow 60\text{ mA}$ (Note 1)		10	50	mV
		$I_O = 5\text{ mA} \rightarrow 100\text{ mA}$		20	100	mV
		$I_O = 5\text{ mA} \rightarrow 150\text{ mA}$		30	160	mV
RR	Ripple Rejection	100 mV(rms), $I_O = 10\text{ mA}$		55		dB
$\Delta V_O / \Delta T_A$	Output Voltage Temperature Dependency	$V_{IN} = 5\text{ V}$, $I_O = 10\text{ mA}$ $-20\text{ }^\circ\text{C} \leq T_A \leq +75\text{ }^\circ\text{C}$		0.05		mV/ $^\circ\text{C}$
V_{NO}	Output Noise Voltage	10 Hz < f < 80 kHz, $I_O = 30\text{ mA}$		30		μV (rms)
V_{REF}	Noise Bypass Terminal Voltage			1.25		V
Control Terminal Specification						
I_{CONT}	Control Current	Output on, $V_{CONT} = 1.8\text{ V}$		12	30	μA
V_{CONT}	Control Voltage	Output on	1.8			V
		Output off			0.6	V
t_r	Output Rise Time	$I_O = 30\text{ mA}$, $V_{CONT} = 0\text{ V} \rightarrow 1.8\text{ V}$		0.3		ms

Note 1: This is a pulse measurement where T_J is constant. The output change due to temperature is not included.

TK112xx A

TK11236A ELECTRICAL CHARACTERISTICS

Test conditions: $T_A = 25\text{ }^\circ\text{C}$, $V_{IN} = 4.6\text{ V}$, $C_P = 0.1\text{ }\mu\text{F}$, unless otherwise specified.

SYMBOL	PARAMETER	TEST CONDITIONS	MIN	TYP	MAX	UNITS
I_{IN}	Quiescent Current	$I_O = 0\text{ mA}$, Except I_{CONT}		170	350	μA
I_{STBY}	Standby Current	$V_{IN} = 8\text{ V}$, at output off			0.1	μA
V_O	Output Voltage	$I_O = 30\text{ mA}$	3.51	3.60	369	V
V_{DROP}	Dropout Voltage	$I_O = 60\text{ mA}$		0.16	0.26	V
		$I_O = 150\text{ mA}$		0.29	0.4	V
I_O	Output Current	$V_{OUT} = 3.3\text{ V}$	180	240		mA
I_{OR}	Recommended Output Current				150	mA
Line Reg	Line Regulation	$V_{IN} = 3.6\text{ V} \rightarrow 9.6\text{ V}$		3.0	20	mV
Load Reg	Load Regulation	$I_O = 5\text{ mA} \rightarrow 60\text{ mA}$ (Note 1)		10	50	mV
		$I_O = 5\text{ mA} \rightarrow 100\text{ mA}$		20	100	mV
		$I_O = 5\text{ mA} \rightarrow 150\text{ mA}$		30	160	mV
RR	Ripple Rejection	100 mV(rms), $I_O = 10\text{ mA}$		55		dB
$\Delta V_O / \Delta T_A$	Output Voltage Temperature Dependency	$V_{IN} = 5.3\text{ V}$, $I_O = 10\text{ mA}$ $-20\text{ }^\circ\text{C} \leq T_A \leq +75\text{ }^\circ\text{C}$		0.1		mV/ $^\circ\text{C}$
V_{NO}	Output Noise Voltage	10 Hz < f < 80 kHz, $I_O = 30\text{ mA}$		30		μV (rms)
V_{REF}	Noise Bypass Terminal Voltage			1.25		V
Control Terminal Specification						
I_{CONT}	Control Current	Output on, $V_{CONT} = 1.8\text{ V}$		12	30	μA
V_{CONT}	Control Voltage	Output on	1.8			V
		Output off			0.6	V
t_r	Output Rise Time	$I_O = 30\text{ mA}$, $V_{CONT} = 0\text{ V} \rightarrow 1.8\text{ V}$		0.3		ms

Note 1: This is a pulse measurement where T_J is constant. The output change due to temperature is not included.

TK11238A ELECTRICAL CHARACTERISTICSTest conditions: $T_A = 25\text{ }^\circ\text{C}$, $V_{IN} = 4.8\text{ V}$, $C_P = 0.1\text{ }\mu\text{F}$, unless otherwise specified.

SYMBOL	PARAMETER	TEST CONDITIONS	MIN	TYP	MAX	UNITS
I_{IN}	Quiescent Current	$I_O = 0\text{ mA}$, Except I_{CONT}		170	350	μA
I_{STBY}	Standby Current	$V_{IN} = 8\text{ V}$, at output off			0.1	μA
V_O	Output Voltage	$I_O = 30\text{ mA}$	3.71	3.80	3.89	V
V_{DROP}	Dropout Voltage	$I_O = 60\text{ mA}$		0.16	0.26	V
		$I_O = 150\text{ mA}$		0.29	0.4	V
I_O	Output Current	$V_{OUT} = 3.5\text{ V}$	180	240		mA
I_{OR}	Recommended Output Current				150	mA
Line Reg	Line Regulation	$V_{IN} = 4.8\text{ V} \rightarrow 9.8\text{ V}$		3.0	20	mV
Load Reg	Load Regulation	$I_O = 5\text{ mA} \rightarrow 60\text{ mA}$ (Note 1)		10	50	mV
		$I_O = 5\text{ mA} \rightarrow 100\text{ mA}$		20	100	mV
		$I_O = 5\text{ mA} \rightarrow 150\text{ mA}$		30	160	mV
RR	Ripple Rejection	100 mV(rms), $I_O = 10\text{ mA}$		55		dB
$\Delta V_O/\Delta T_A$	Output Voltage Temperature Dependency	$V_{IN} = 5.3\text{ V}$, $I_O = 10\text{ mA}$ $-20\text{ }^\circ\text{C} \leq T_A \leq +75\text{ }^\circ\text{C}$		0.1		mV/ $^\circ\text{C}$
V_{NO}	Output Noise Voltage	10 Hz < f < 80 kHz, $I_O = 30\text{ mA}$		30		μV (rms)
V_{REF}	Noise Bypass Terminal Voltage			1.25		V
Control Terminal Specification						
I_{CONT}	Control Current	Output on, $V_{CONT} = 1.8\text{ V}$		12	30	μA
V_{CONT}	Control Voltage	Output on	1.8			V
		Output off			0.6	V
t_r	Output Rise Time	$I_O = 30\text{ mA}$, $V_{CONT} = 0\text{ V} \rightarrow 1.8\text{ V}$		0.3		ms

Note 1: This is a pulse measurement where T_J is constant. The output change due to temperature is not included.

TK112xx A

TK11240A ELECTRICAL CHARACTERISTICS

Test conditions: $T_A = 25\text{ }^\circ\text{C}$, $V_{IN} = 5.0\text{ V}$, $C_P = 0.1\text{ }\mu\text{F}$, unless otherwise specified.

SYMBOL	PARAMETER	TEST CONDITIONS	MIN	TYP	MAX	UNITS
I_{IN}	Quiescent Current	$I_O = 0\text{ mA}$, Except I_{CONT}		170	350	μA
I_{STBY}	Standby Current	$V_{IN} = 8\text{ V}$, at output off			0.1	μA
V_O	Output Voltage	$I_O = 30\text{ mA}$	3.90	4.00	4.10	V
V_{DROP}	Dropout Voltage	$I_O = 60\text{ mA}$		0.16	0.26	V
		$I_O = 150\text{ mA}$		0.29	0.4	V
I_O	Output Current	$V_{OUT} = 3.7\text{ V}$	180	240		mA
I_{OR}	Recommended Output Current				150	mA
Line Reg	Line Regulation	$V_{IN} = 5\text{ V} \rightarrow 10\text{ V}$		3.0	20	mV
Load Reg	Load Regulation	$I_O = 5\text{ mA} \rightarrow 60\text{ mA}$ (Note 1)		10	50	mV
		$I_O = 5\text{ mA} \rightarrow 100\text{ mA}$		20	100	mV
		$I_O = 5\text{ mA} \rightarrow 150\text{ mA}$		30	160	mV
RR	Ripple Rejection	100 mV(rms), $I_O = 10\text{ mA}$		55		dB
$\Delta V_O / \Delta T_A$	Output Voltage Temperature Dependency	$V_{IN} = 5.5\text{ V}$, $I_O = 10\text{ mA}$ $-20\text{ }^\circ\text{C} \leq T_A \leq +75\text{ }^\circ\text{C}$		0.1		mV/ $^\circ\text{C}$
V_{NO}	Output Noise Voltage	10 Hz < f < 80 kHz, $I_O = 30\text{ mA}$		40		μV (rms)
V_{REF}	Noise Bypass Terminal Voltage			1.25		V
Control Terminal Specification						
I_{CONT}	Control Current	Output on, $V_{CONT} = 1.8\text{ V}$		12	30	μA
V_{CONT}	Control Voltage	Output on	1.8			V
		Output off			0.6	V
t_r	Output Rise Time	$I_O = 30\text{ mA}$, $V_{CONT} = 0\text{ V} \rightarrow 1.8\text{ V}$		0.3		ms

Note 1: This is a pulse measurement where T_J is constant. The output change due to temperature is not included.

TK11242A ELECTRICAL CHARACTERISTICSTest conditions: $T_A = 25\text{ }^\circ\text{C}$, $V_{IN} = 5.2\text{ V}$, $C_P = 0.1\text{ }\mu\text{F}$, unless otherwise specified.

SYMBOL	PARAMETER	TEST CONDITIONS	MIN	TYP	MAX	UNITS
I_{IN}	Quiescent Current	$I_O = 0\text{ mA}$, Except I_{CONT}		170	350	μA
I_{STBY}	Standby Current	$V_{IN} = 8\text{ V}$, at output off			0.1	μA
V_O	Output Voltage	$I_O = 30\text{ mA}$	4.10	4.20	4.30	V
V_{DROP}	Dropout Voltage	$I_O = 60\text{ mA}$		0.16	0.26	V
		$I_O = 150\text{ mA}$		0.29	0.4	V
I_O	Output Current	$V_{OUT} = 3.9\text{ V}$		240		mA
I_{OR}	Recommended Output Current				150	mA
Line Reg	Line Regulation	$V_{IN} = 5.2\text{ V} \rightarrow 10.2\text{ V}$		3.0	20	mV
Load Reg	Load Regulation	$I_O = 5\text{ mA} \rightarrow 60\text{ mA}$ (Note 1)		10	50	mV
		$I_O = 5\text{ mA} \rightarrow 100\text{ mA}$		20	100	mV
		$I_O = 5\text{ mA} \rightarrow 150\text{ mA}$		30	160	mV
RR	Ripple Rejection	100 mV(rms), $I_O = 10\text{ mA}$		55		dB
$\Delta V_O / \Delta T_A$	Output Voltage Temperature Dependency	$V_{IN} = 5.7\text{ V}$, $I_O = 10\text{ mA}$ $-20\text{ }^\circ\text{C} \leq T_A \leq +75\text{ }^\circ\text{C}$		0.1		mV/ $^\circ\text{C}$
V_{NO}	Output Noise Voltage	10 Hz < f < 80 kHz, $I_O = 30\text{ mA}$		40		μV (rms)
V_{REF}	Noise Bypass Terminal Voltage			1.25		V
Control Terminal Specification						
I_{CONT}	Control Current	Output on, $V_{CONT} = 1.8\text{ V}$		12	30	μA
V_{CONT}	Control Voltage	Output on	1.8			V
		Output off			0.6	V
t_r	Output Rise Time	$I_O = 30\text{ mA}$, $V_{CONT} = 0\text{ V} \rightarrow 1.8\text{ V}$		0.3		ms

Note 1: This is a pulse measurement where T_J is constant. The output change due to temperature is not included.

TK112xx A

TK11245A ELECTRICAL CHARACTERISTICS

Test conditions: $T_A = 25\text{ }^\circ\text{C}$, $V_{IN} = 5.5\text{ V}$, $C_P = 0.1\text{ }\mu\text{F}$, unless otherwise specified.

SYMBOL	PARAMETER	TEST CONDITIONS	MIN	TYP	MAX	UNITS
I_{IN}	Quiescent Current	$I_O = 0\text{ mA}$, Except I_{CONT}		170	350	μA
I_{STBY}	Standby Current	$V_{IN} = 8\text{ V}$, at output off			0.1	μA
V_O	Output Voltage	$I_O = 30\text{ mA}$	4.39	4.50	4.61	V
V_{DROP}	Dropout Voltage	$I_O = 60\text{ mA}$		0.16	0.26	V
		$I_O = 150\text{ mA}$		0.29	0.4	V
I_O	Output Current	$V_{OUT} = 4.2\text{ V}$	180	240		mA
I_{OR}	Recommended Output Current				150	mA
Line Reg	Line Regulation	$V_{IN} = 5\text{ V} \rightarrow 10\text{ V}$		3.0	20	mV
Load Reg	Load Regulation	$I_O = 5\text{ mA} \rightarrow 60\text{ mA}$ (Note 1)		10	50	mV
		$I_O = 5\text{ mA} \rightarrow 100\text{ mA}$		20	100	mV
		$I_O = 5\text{ mA} \rightarrow 150\text{ mA}$		30	160	mV
RR	Ripple Rejection	100 mV(rms), $I_O = 10\text{ mA}$		55		dB
$\Delta V_O / \Delta T_A$	Output Voltage Temperature Dependency	$V_{IN} = 6\text{ V}$, $I_O = 10\text{ mA}$ $-20\text{ }^\circ\text{C} \leq T_A \leq +75\text{ }^\circ\text{C}$		0.1		mV/ $^\circ\text{C}$
V_{NO}	Output Noise Voltage	10 Hz < f < 80 kHz, $I_O = 30\text{ mA}$		40		μV (rms)
V_{REF}	Noise Bypass Terminal Voltage			1.25		V
Control Terminal Specification						
I_{CONT}	Control Current	Output on, $V_{CONT} = 1.8\text{ V}$		12	30	μA
V_{CONT}	Control Voltage	Output on	1.8			V
		Output off			0.6	V
t_r	Output Rise Time	$I_O = 30\text{ mA}$, $V_{CONT} = 0\text{ V} \rightarrow 1.8\text{ V}$		0.3		ms

Note 1: This is a pulse measurement where T_J is constant. The output change due to temperature is not included.

TK11248A ELECTRICAL CHARACTERISTICSTest conditions: $T_A = 25\text{ }^\circ\text{C}$, $V_{IN} = 5.8\text{ V}$, $C_P = 0.1\text{ }\mu\text{F}$, unless otherwise specified.

SYMBOL	PARAMETER	TEST CONDITIONS	MIN	TYP	MAX	UNITS
I_{IN}	Quiescent Current	$I_O = 0\text{ mA}$, Except I_{CONT}		170	350	μA
I_{STBY}	Standby Current	$V_{IN} = 8\text{ V}$, at output off			0.1	μA
V_O	Output Voltage	$I_O = 30\text{ mA}$	4.68	4.80	4.92	V
V_{DROP}	Dropout Voltage	$I_O = 60\text{ mA}$		0.16	0.26	V
		$I_O = 150\text{ mA}$		0.29	0.4	V
I_O	Output Current	$V_{OUT} = 4.5\text{ V}$	180	240		mA
I_{OR}	Recommended Output Current				150	mA
Line Reg	Line Regulation	$V_{IN} = 5.8\text{ V} \rightarrow 10.8\text{ V}$		3.0	20	mV
Load Reg	Load Regulation	$I_O = 5\text{ mA} \rightarrow 60\text{ mA}$ (Note 1)		10	50	mV
		$I_O = 5\text{ mA} \rightarrow 100\text{ mA}$		20	100	mV
		$I_O = 5\text{ mA} \rightarrow 150\text{ mA}$		30	160	mV
RR	Ripple Rejection	100 mV(rms), $I_O = 10\text{ mA}$		55		dB
$\Delta V_O/\Delta T_A$	Output Voltage Temperature Dependency	$V_{IN} = 6.3\text{ V}$, $I_O = 10\text{ mA}$ $-20\text{ }^\circ\text{C} \leq T_A \leq +75\text{ }^\circ\text{C}$		0.1		mV/ $^\circ\text{C}$
V_{NO}	Output Noise Voltage	10 Hz < f < 80 kHz, $I_O = 30\text{ mA}$		40		μV (rms)
V_{REF}	Noise Bypass Terminal Voltage			1.25		V
Control Terminal Specification						
I_{CONT}	Control Current	Output on, $V_{CONT} = 1.8\text{ V}$		12	30	μA
V_{CONT}	Control Voltage	Output on	1.8			V
		Output off			0.6	V
t_r	Output Rise Time	$I_O = 30\text{ mA}$, $V_{CONT} = 0\text{ V} \rightarrow 1.8\text{ V}$		0.3		ms

Note 1: This is a pulse measurement where T_J is constant. The output change due to temperature is not included.

TK112xx A

TK11249A ELECTRICAL CHARACTERISTICS

Test conditions: $T_A = 25\text{ }^\circ\text{C}$, $V_{IN} = 5.9\text{ V}$, $C_P = 0.1\text{ }\mu\text{F}$, unless otherwise specified.

SYMBOL	PARAMETER	TEST CONDITIONS	MIN	TYP	MAX	UNITS
I_{IN}	Quiescent Current	$I_O = 0\text{ mA}$, Except I_{CONT}		170	350	μA
I_{STBY}	Standby Current	$V_{IN} = 8\text{ V}$, at output off			0.1	μA
V_O	Output Voltage	$I_O = 30\text{ mA}$	4.78	4.90	5.02	V
V_{DROP}	Dropout Voltage	$I_O = 60\text{ mA}$		0.16	0.26	V
		$I_O = 150\text{ mA}$		0.29	0.4	V
I_O	Output Current	$V_{OUT} = 4.6\text{ V}$	180	240		mA
I_{OR}	Recommended Output Current				150	mA
Line Reg	Line Regulation	$V_{IN} = 5.9\text{ V} \rightarrow 10.9\text{ V}$		3.0	20	mV
Load Reg	Load Regulation	$I_O = 5\text{ mA} \rightarrow 60\text{ mA}$ (Note 1)		10	50	mV
		$I_O = 5\text{ mA} \rightarrow 100\text{ mA}$		20	100	mV
		$I_O = 5\text{ mA} \rightarrow 150\text{ mA}$		30	160	mV
RR	Ripple Rejection	100 mV(rms), $I_O = 10\text{ mA}$		55		dB
$\Delta V_O/\Delta T_A$	Output Voltage Temperature Dependency	$V_{IN} = 6.4\text{ V}$, $I_O = 10\text{ mA}$ $-20\text{ }^\circ\text{C} \leq T_A \leq +75\text{ }^\circ\text{C}$		0.2		mV/ $^\circ\text{C}$
V_{NO}	Output Noise Voltage	10 Hz < f < 80 kHz, $I_O = 30\text{ mA}$		40		μV (rms)
V_{REF}	Noise Bypass Terminal Voltage			1.25		V
Control Terminal Specification						
I_{CONT}	Control Current	Output on, $V_{CONT} = 1.8\text{ V}$		12	30	μA
V_{CONT}	Control Voltage	Output on	1.8			V
		Output off			0.6	V
t_r	Output Rise Time	$I_O = 30\text{ mA}$, $V_{CONT} = 0\text{ V} \rightarrow 1.8\text{ V}$		0.3		ms

Note 1: This is a pulse measurement where T_j is constant. The output change due to temperature is not included.

TK11250A ELECTRICAL CHARACTERISTICSTest conditions: $T_A = 25\text{ }^\circ\text{C}$, $V_{IN} = 6.0\text{ V}$, $C_P = 0.1\text{ }\mu\text{F}$, unless otherwise specified.

SYMBOL	PARAMETER	TEST CONDITIONS	MIN	TYP	MAX	UNITS
I_{IN}	Quiescent Current	$I_O = 0\text{ mA}$, Except I_{CONT}		170	350	μA
I_{STBY}	Standby Current	$V_{IN} = 8\text{ V}$, at output off			0.1	μA
V_O	Output Voltage	$I_O = 30\text{ mA}$	4.88	5.00	5.12	V
V_{DROP}	Dropout Voltage	$I_O = 60\text{ mA}$		0.16	0.26	V
		$I_O = 150\text{ mA}$		0.29	0.4	V
I_O	Output Current	$V_{OUT} = 4.7\text{ V}$	180	240		mA
I_{OR}	Recommended Output Current				150	mA
Line Reg	Line Regulation	$V_{IN} = 6\text{ V} \rightarrow 11\text{ V}$		3.0	20	mV
Load Reg	Load Regulation	$I_O = 5\text{ mA} \rightarrow 60\text{ mA}$ (Note 1)		10	50	mV
		$I_O = 5\text{ mA} \rightarrow 100\text{ mA}$		20	100	mV
		$I_O = 5\text{ mA} \rightarrow 150\text{ mA}$		30	160	mV
RR	Ripple Rejection	100 mV(rms), $I_O = 10\text{ mA}$		55		dB
$\Delta V_O/\Delta T_A$	Output Voltage Temperature Dependency	$V_{IN} = 6.5\text{ V}$, $I_O = 10\text{ mA}$ $-20\text{ }^\circ\text{C} \leq T_A \leq +75\text{ }^\circ\text{C}$		0.2		mV/ $^\circ\text{C}$
V_{NO}	Output Noise Voltage	10 Hz < f < 80 kHz, $I_O = 30\text{ mA}$		50		μV (rms)
V_{REF}	Noise Bypass Terminal Voltage			1.25		V
Control Terminal Specification						
I_{CONT}	Control Current	Output on, $V_{CONT} = 1.8\text{ V}$		12	30	μA
V_{CONT}	Control Voltage	Output on	1.8			V
		Output off			0.6	V
t_r	Output Rise Time	$I_O = 30\text{ mA}$, $V_{CONT} = 0\text{ V} \rightarrow 1.8\text{ V}$		0.3		ms

Note 1: This is a pulse measurement where T_j is constant. The output change due to temperature is not included.

TK112xx A

TK11255A ELECTRICAL CHARACTERISTICS

Test conditions: $T_A = 25\text{ }^\circ\text{C}$, $V_{IN} = 6.5\text{ V}$, $C_P = 0.1\text{ }\mu\text{F}$, unless otherwise specified.

SYMBOL	PARAMETER	TEST CONDITIONS	MIN	TYP	MAX	UNITS
I_{IN}	Quiescent Current	$I_O = 0\text{ mA}$, Except I_{CONT}		170	350	μA
I_{STBY}	Standby Current	$V_{IN} = 8\text{ V}$, at output off			0.1	μA
V_O	Output Voltage	$I_O = 30\text{ mA}$	5.36	5.5	5.63	V
V_{DROP}	Dropout Voltage	$I_O = 60\text{ mA}$		0.16	0.26	V
		$I_O = 150\text{ mA}$		0.29	0.4	V
I_O	Output Current	$V_{OUT} = 5.2\text{ V}$	180	240		mA
I_{OR}	Recommended Output Current				150	mA
Line Reg	Line Regulation	$V_{IN} = 6.5\text{ V} \rightarrow 11.5\text{ V}$		3.0	20	mV
Load Reg	Load Regulation	$I_O = 5\text{ mA} \rightarrow 60\text{ mA}$ (Note 1)		10	50	mV
		$I_O = 5\text{ mA} \rightarrow 100\text{ mA}$		20	100	mV
		$I_O = 5\text{ mA} \rightarrow 150\text{ mA}$		30	160	mV
RR	Ripple Rejection	100 mV(rms), $I_O = 10\text{ mA}$		55		dB
$\Delta V_O / \Delta T_A$	Output Voltage Temperature Dependency	$V_{IN} = 7\text{ V}$, $I_O = 10\text{ mA}$ $-20\text{ }^\circ\text{C} \leq T_A \leq +75\text{ }^\circ\text{C}$		0.2		mV/ $^\circ\text{C}$
V_{NO}	Output Noise Voltage	10 Hz < f < 80 kHz, $I_O = 30\text{ mA}$		50		μV (rms)
V_{REF}	Noise Bypass Terminal Voltage			1.25		V
Control Terminal Specification						
I_{CONT}	Control Current	Output on, $V_{CONT} = 1.8\text{ V}$		12	30	μA
V_{CONT}	Control Voltage	Output on	1.8			V
		Output off			0.6	V
t_r	Output Rise Time	$I_O = 30\text{ mA}$, $V_{CONT} = 0\text{ V} \rightarrow 1.8\text{ V}$		0.3		ms

Note 1: This is a pulse measurement where T_J is constant. The output change due to temperature is not included.

TEST CIRCUITS

SOT-23L

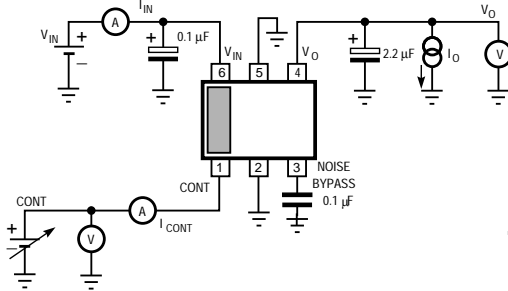

SOT-89-5

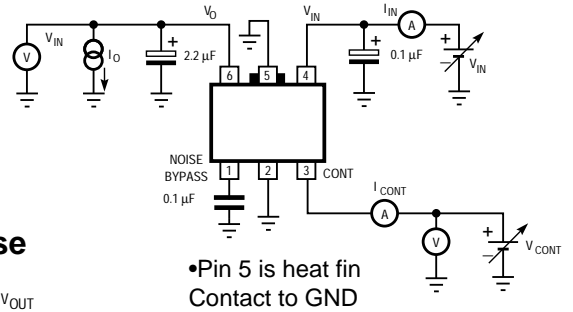

Transient Response

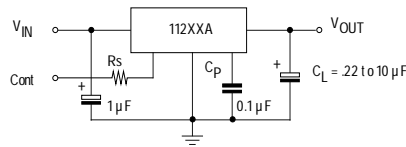

•Pin 5 is heat fin Contact to GND

TYPICAL PERFORMANCE CHARACTERISTICS

T_A = 25 °C unless otherwise specified

LOAD REGULATION

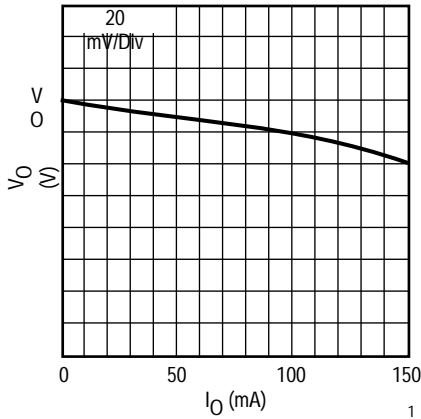

LINE REGULATION

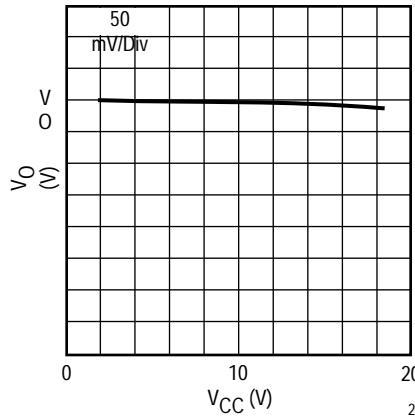

SUPPLY VOLTAGE vs. INPUT CURRENT (NO LOAD)

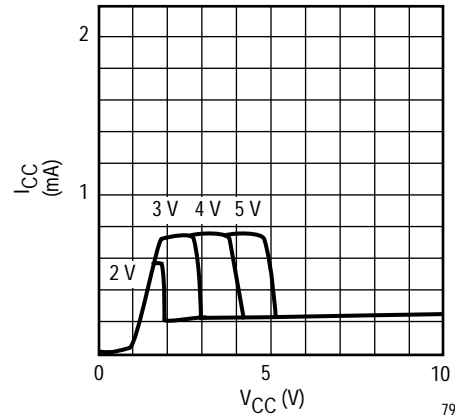

QUIESCENT CURRENT vs. LOAD CURRENT

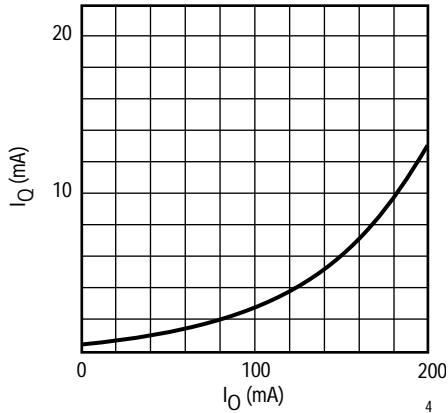

OUTPUT VOLTAGE vs. INPUT VOLTAGE

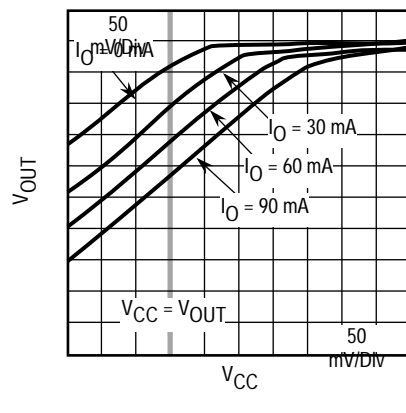

DROPOUT VOLTAGE vs. LOAD CURRENT

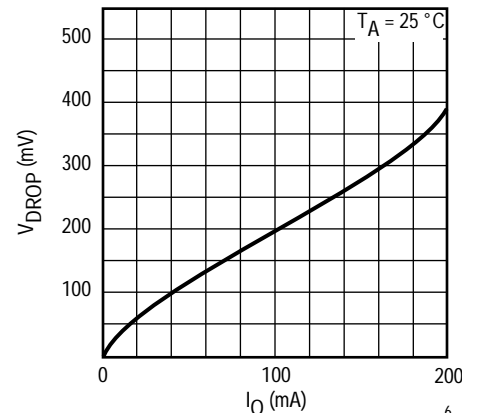

TYPICAL PERFORMANCE CHARACTERISTICS (CONT.)

$T_A = 25^\circ\text{C}$ unless otherwise specified

SHORT CURRENT vs. OUTPUT VOLTAGE

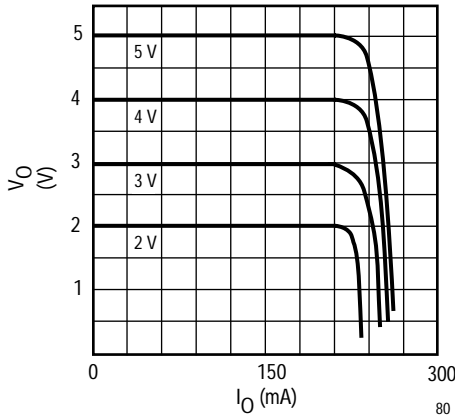

CONTROL CURRENT vs. CONTROL VOLTAGE

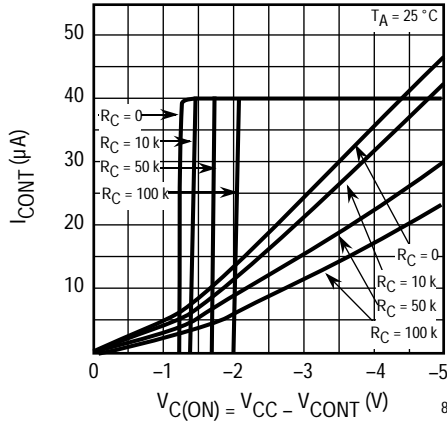

QUIESCENT CURRENT vs. INPUT VOLTAGE (OFF)

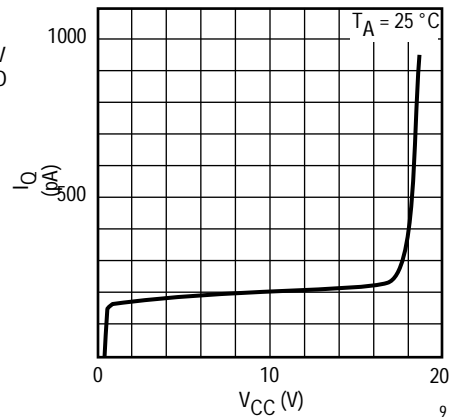

NOISE LEVEL vs. FREQUENCY

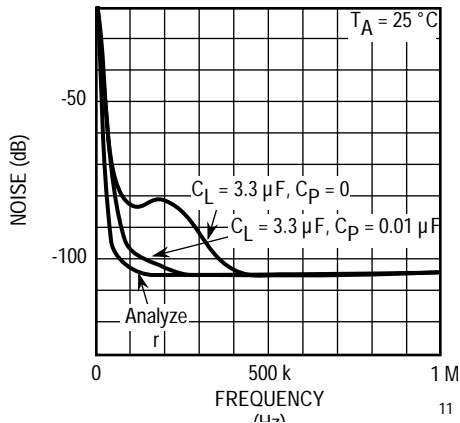

RIPPLE REJECTION vs. FREQUENCY

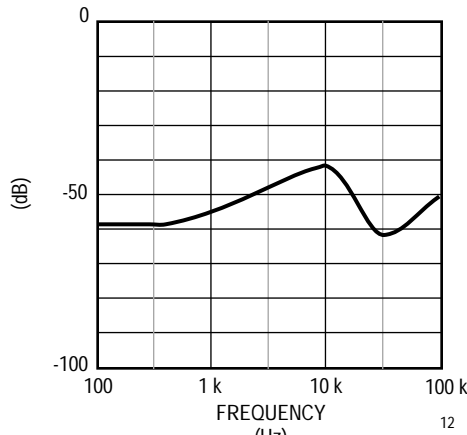

LINE TRANSIENT RESPONSE

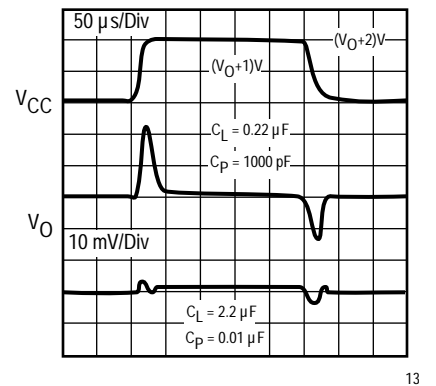

LOAD TRANSIENT RESPONSE

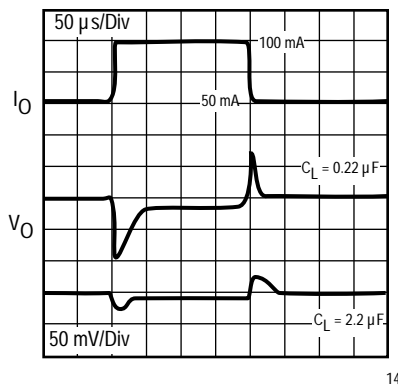

OUTPUT VOLTAGE RESPONSE (OFF → ON)

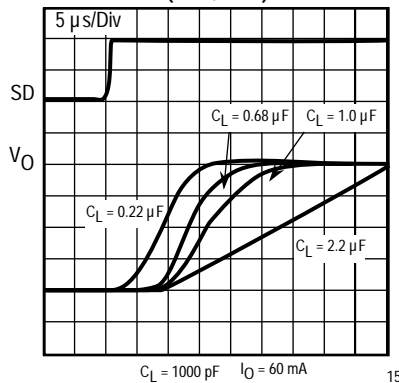

NOISE LEVEL vs. BYPASS CAPACITOR

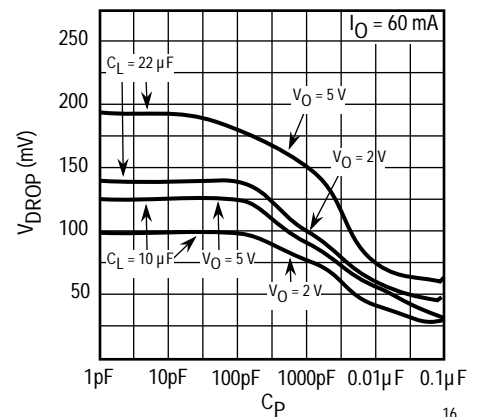

TYPICAL PERFORMANCE CHARACTERISTICS (CONT.)

$T_A = 25\text{ }^\circ\text{C}$ unless otherwise specified

QUIESCENT CURRENT vs. TEMPERATURE

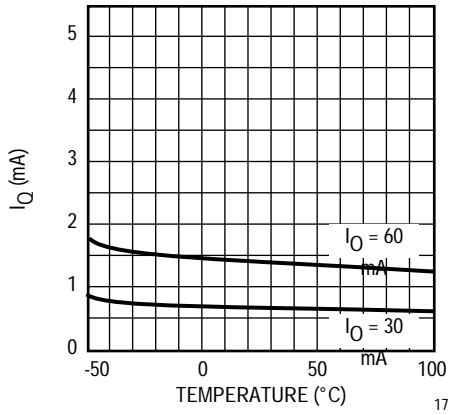

DROPOUT VOLTAGE vs. TEMPERATURE

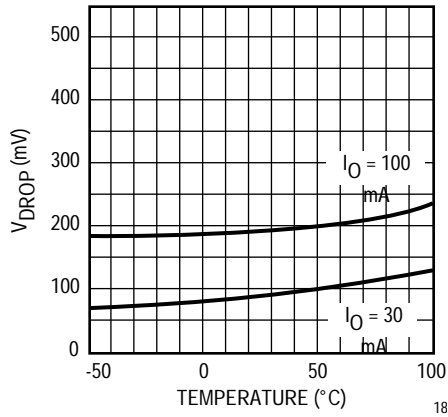

CONTROL CURRENT vs. TEMPERATURE

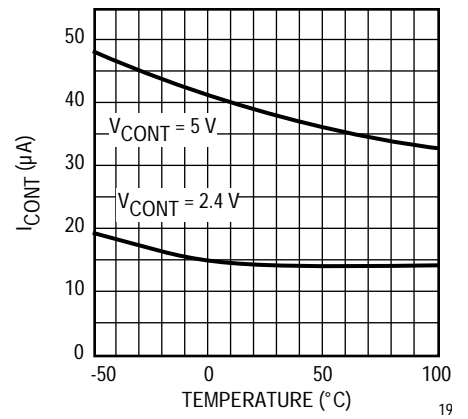

CONTROL VOLTAGE THRESHOLD vs. TEMPERATURE

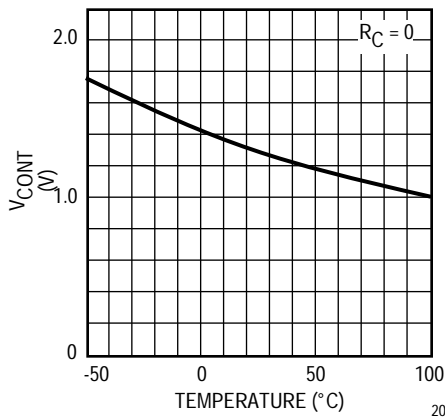

OUTPUT CURRENT vs. TEMPERATURE

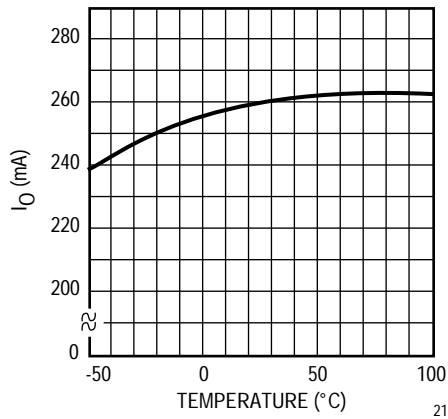

OUTPUT VOLTAGE VARIATION

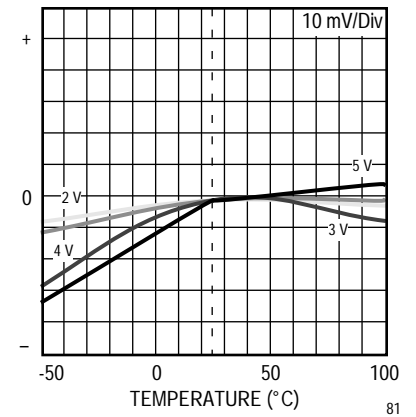

TK11220A

OUTPUT VOLTAGE vs. LOAD CURRENT

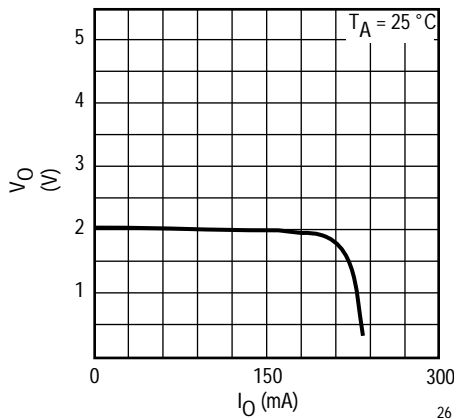

INPUT CURRENT vs. INPUT VOLTAGE (NO LOAD)

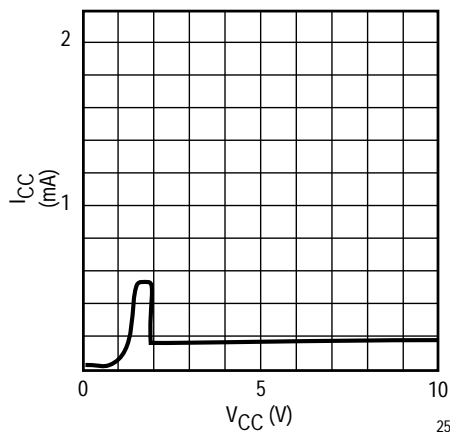

OUTPUT VOLTAGE CHANGE vs. TEMPERATURE

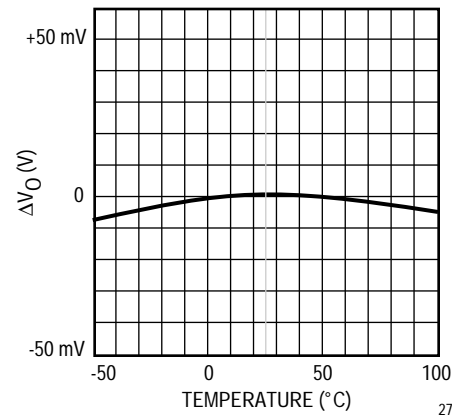

TK112xx A

TYPICAL PERFORMANCE CHARACTERISTICS (CONT.)

$T_A = 25^\circ\text{C}$ unless otherwise specified

TK11221A

OUTPUT VOLTAGE vs. LOAD CURRENT

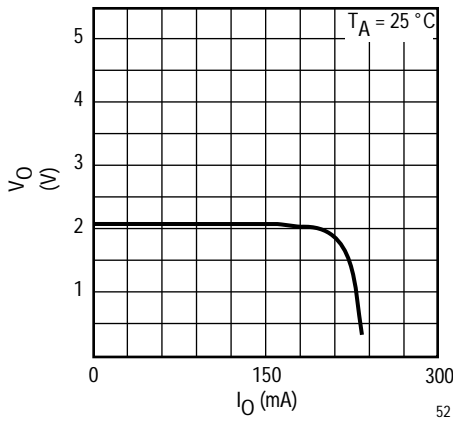

INPUT CURRENT vs. INPUT VOLTAGE (NO LOAD)

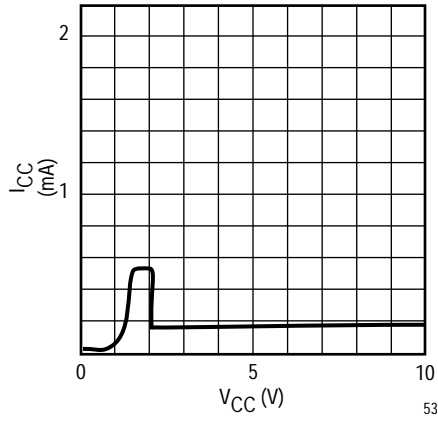

OUTPUT VOLTAGE CHANGE vs. TEMPERATURE

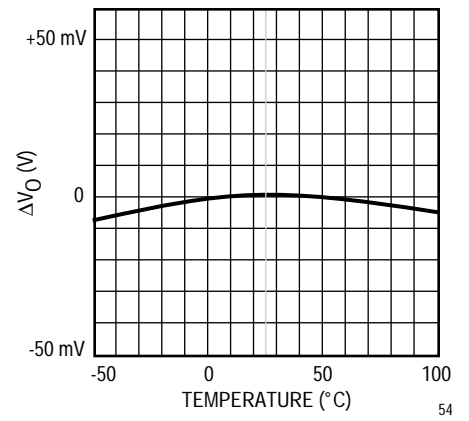

TK11222A

OUTPUT VOLTAGE vs. LOAD CURRENT

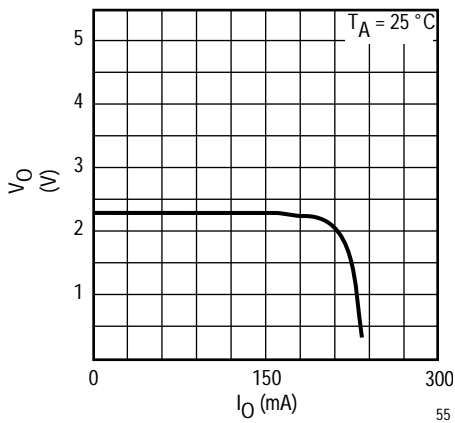

INPUT CURRENT vs. INPUT VOLTAGE (NO LOAD)

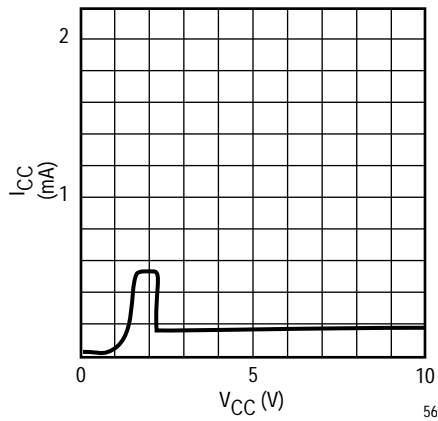

OUTPUT VOLTAGE CHANGE vs. TEMPERATURE

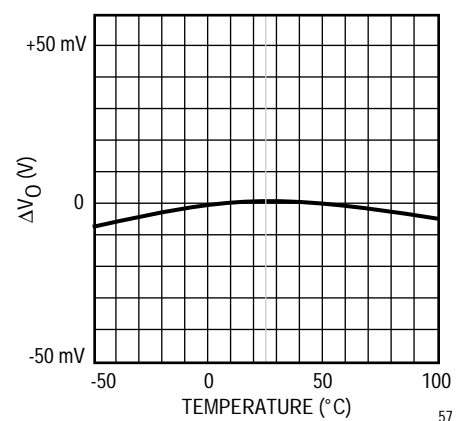

TK11225A

OUTPUT VOLTAGE vs. LOAD CURRENT

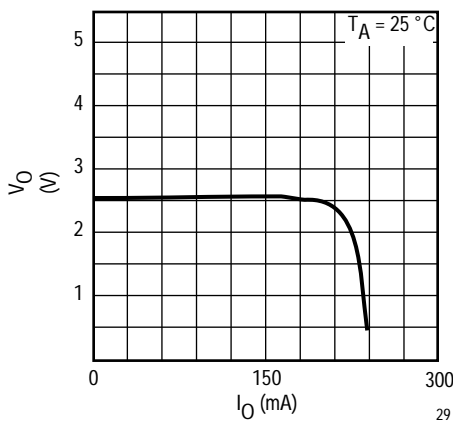

INPUT CURRENT vs. INPUT VOLTAGE (NO LOAD)

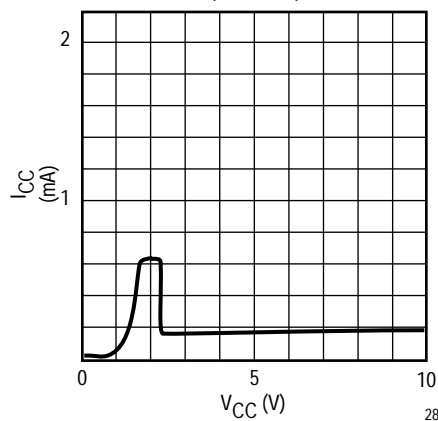

OUTPUT VOLTAGE CHANGE vs. TEMPERATURE

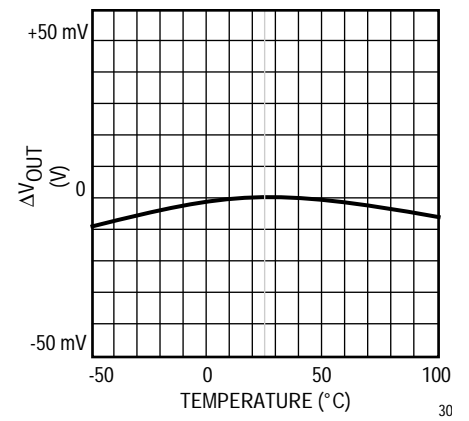

TYPICAL PERFORMANCE CHARACTERISTICS (CONT.)

TK11228A

$T_A = 25\text{ }^\circ\text{C}$ unless otherwise specified

OUTPUT VOLTAGE vs. LOAD CURRENT

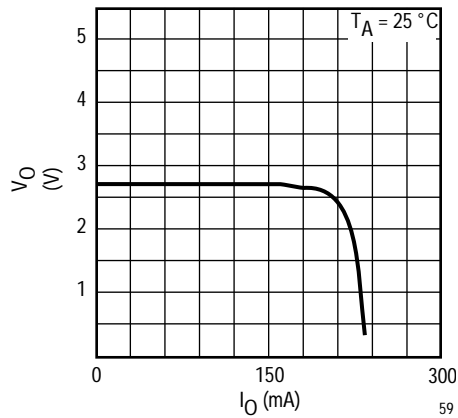

INPUT CURRENT vs. INPUT VOLTAGE (NO LOAD)

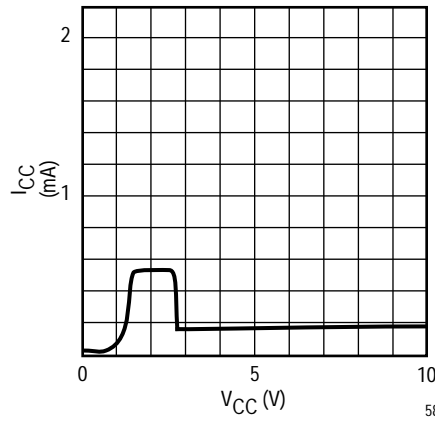

OUTPUT VOLTAGE CHANGE vs. TEMPERATURE

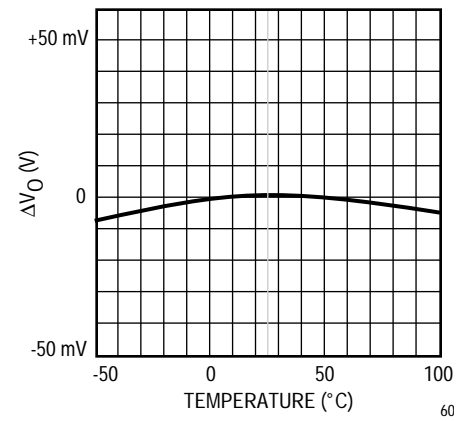

TK11229A

OUTPUT VOLTAGE vs. LOAD CURRENT

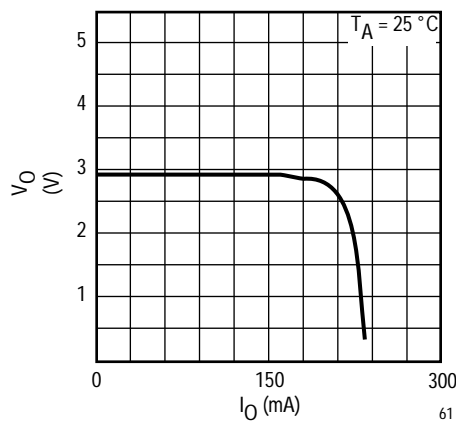

INPUT CURRENT vs. INPUT VOLTAGE (NO LOAD)

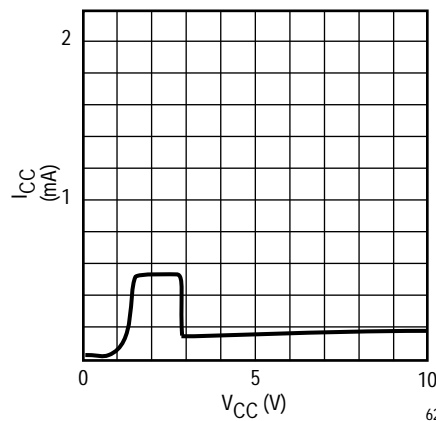

OUTPUT VOLTAGE CHANGE vs. TEMPERATURE

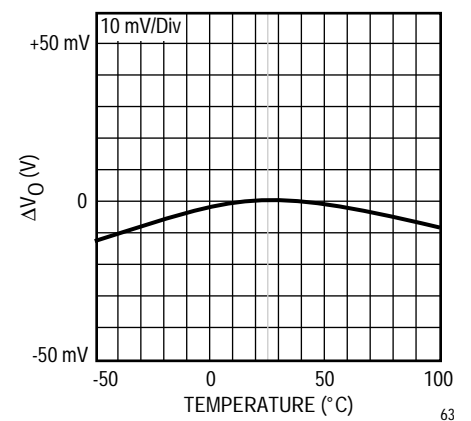

TK11230A

OUTPUT VOLTAGE vs. LOAD CURRENT

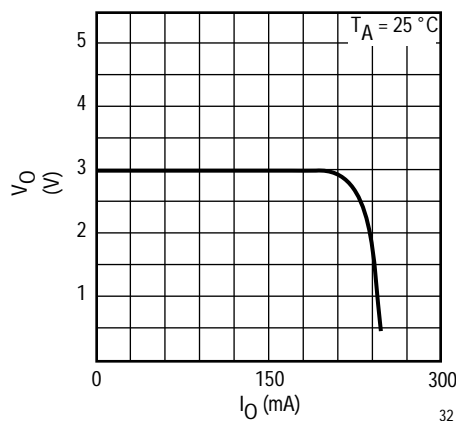

INPUT CURRENT vs. INPUT VOLTAGE (NO LOAD)

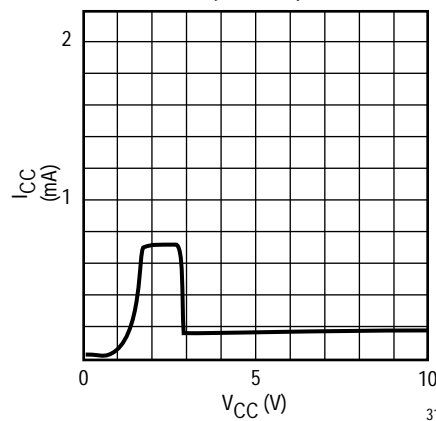

OUTPUT VOLTAGE CHANGE vs. TEMPERATURE

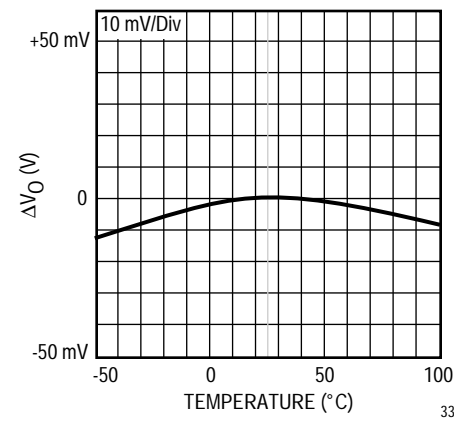

TK112xx A

TYPICAL PERFORMANCE CHARACTERISTICS (CONT.)

TK11231A

$T_A = 25^\circ\text{C}$ unless otherwise specified

OUTPUT VOLTAGE vs. LOAD CURRENT

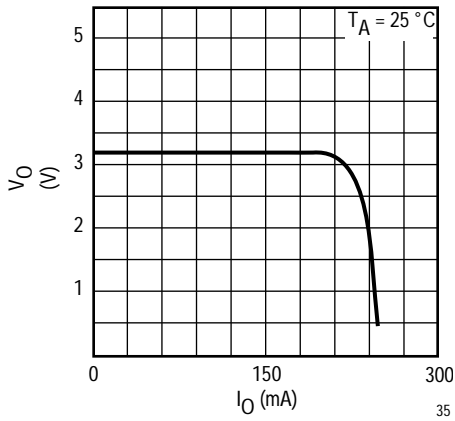

INPUT CURRENT vs. INPUT VOLTAGE (NO LOAD)

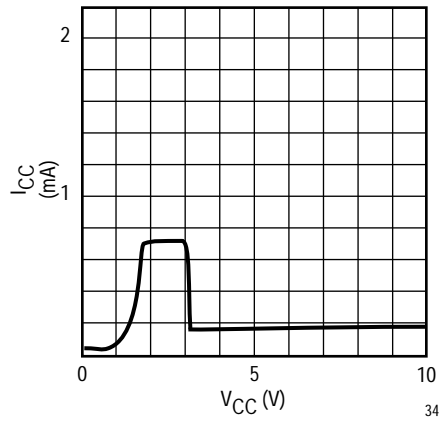

OUTPUT VOLTAGE CHANGE vs. TEMPERATURE

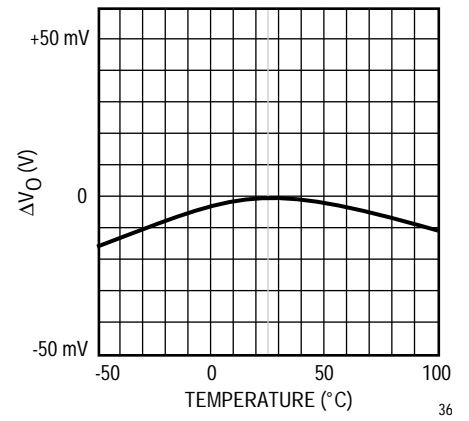

TK11233A

OUTPUT VOLTAGE vs. LOAD CURRENT

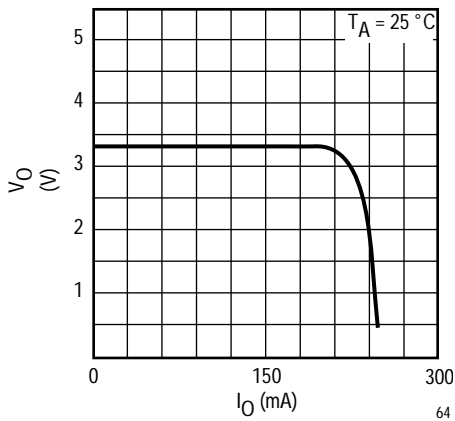

INPUT CURRENT vs. INPUT VOLTAGE (NO LOAD)

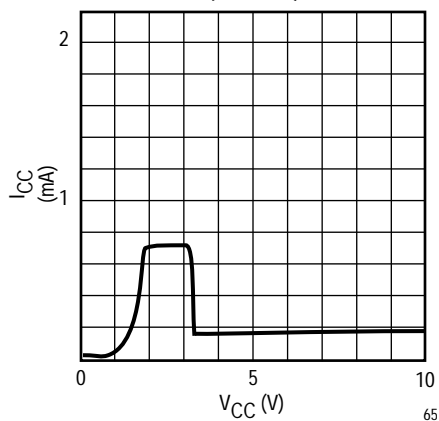

OUTPUT VOLTAGE CHANGE vs. TEMPERATURE

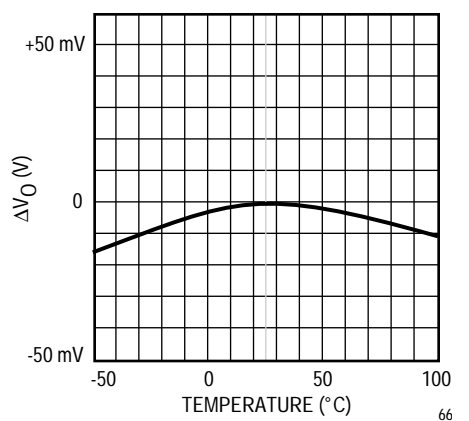

TK11235A

OUTPUT VOLTAGE vs. LOAD CURRENT

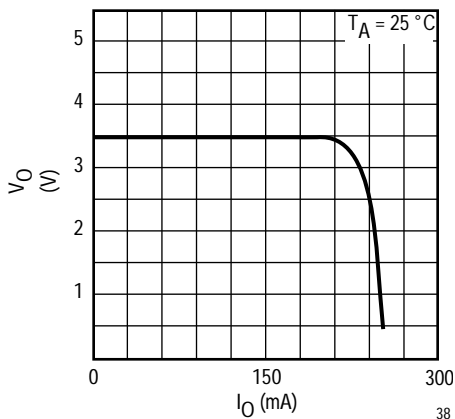

INPUT CURRENT vs. INPUT VOLTAGE (NO LOAD)

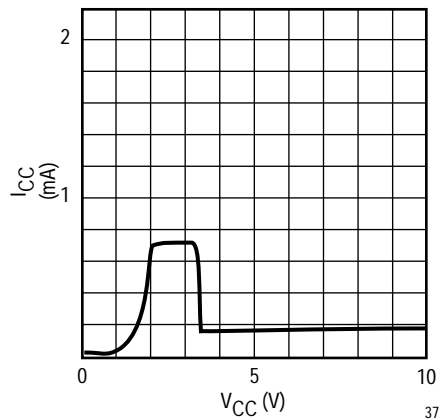

OUTPUT VOLTAGE CHANGE vs. TEMPERATURE

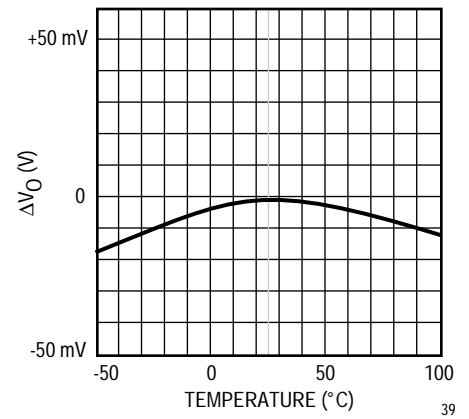

TYPICAL PERFORMANCE CHARACTERISTICS (CONT.)

TK11236A

$T_A = 25^\circ\text{C}$ unless otherwise specified

OUTPUT VOLTAGE vs. LOAD CURRENT

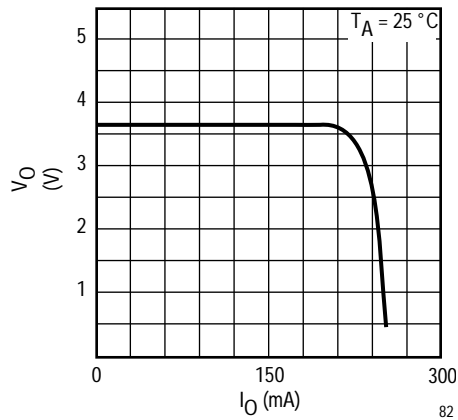

INPUT CURRENT vs. INPUT VOLTAGE (NO LOAD)

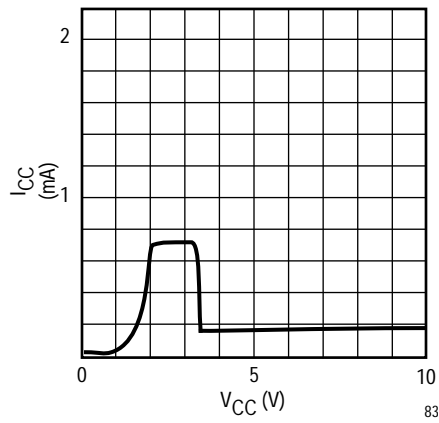

OUTPUT VOLTAGE CHANGE vs. TEMPERATURE

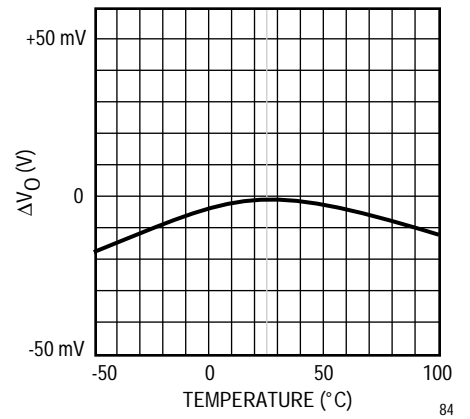

TK11238A

OUTPUT VOLTAGE vs. LOAD CURRENT

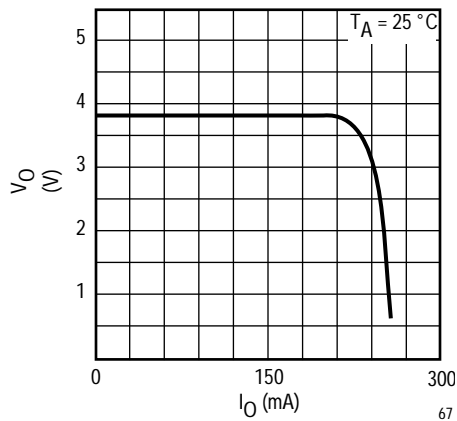

INPUT CURRENT vs. INPUT VOLTAGE (NO LOAD)

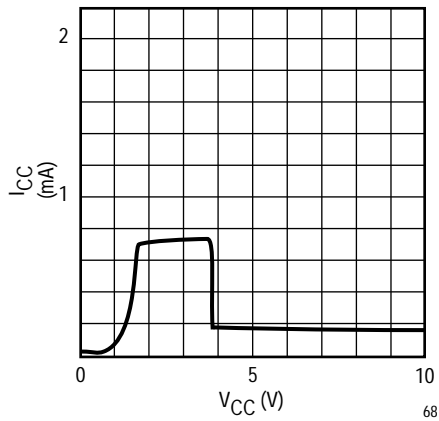

OUTPUT VOLTAGE CHANGE vs. TEMPERATURE

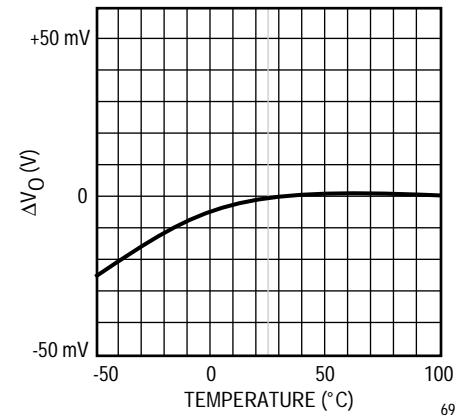

TK11240A

OUTPUT VOLTAGE vs. LOAD CURRENT

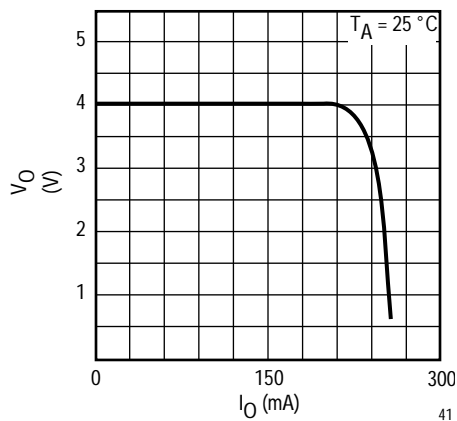

INPUT CURRENT vs. INPUT VOLTAGE (NO LOAD)

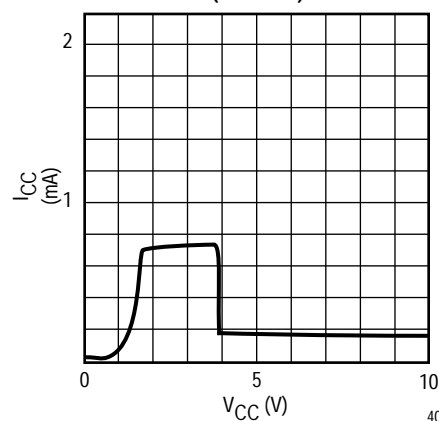

OUTPUT VOLTAGE CHANGE vs. TEMPERATURE

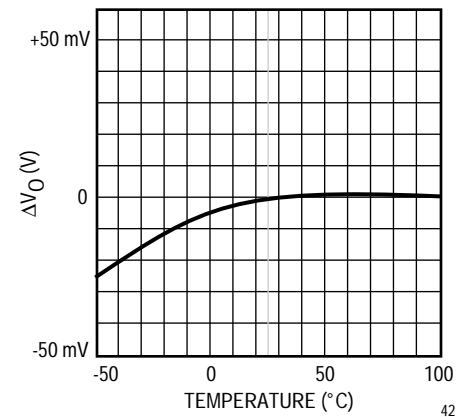

TK112xx A

TYPICAL PERFORMANCE CHARACTERISTICS (CONT.)

TK11242A

$T_A = 25^\circ\text{C}$ unless otherwise specified

OUTPUT VOLTAGE vs. LOAD CURRENT

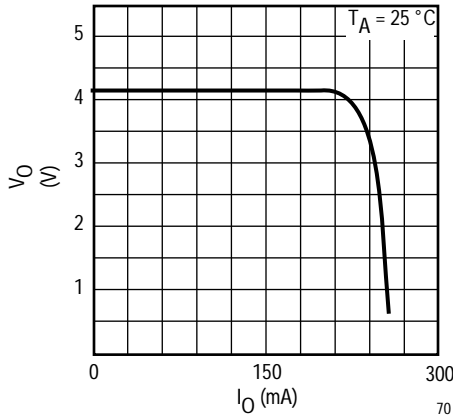

INPUT CURRENT vs. INPUT VOLTAGE (NO LOAD)

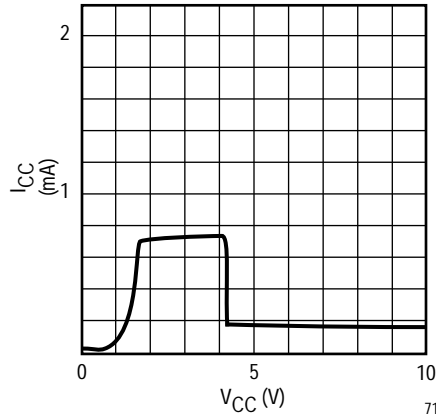

OUTPUT VOLTAGE CHANGE vs. TEMPERATURE

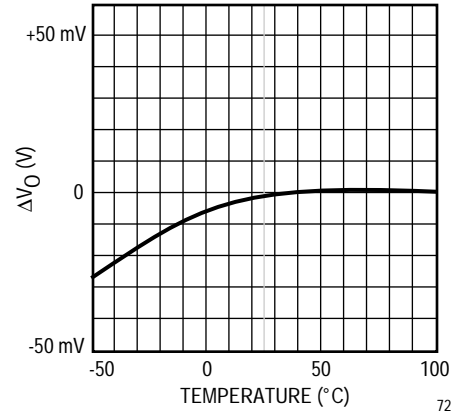

TK11245A

OUTPUT VOLTAGE vs. LOAD CURRENT

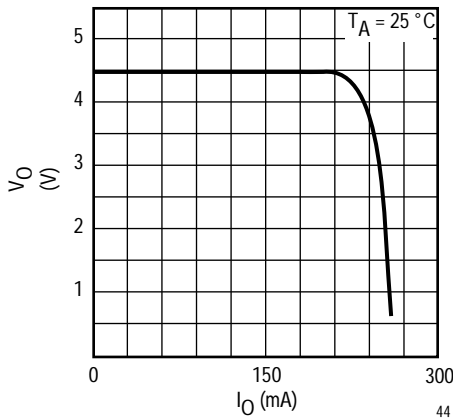

INPUT CURRENT vs. INPUT VOLTAGE (NO LOAD)

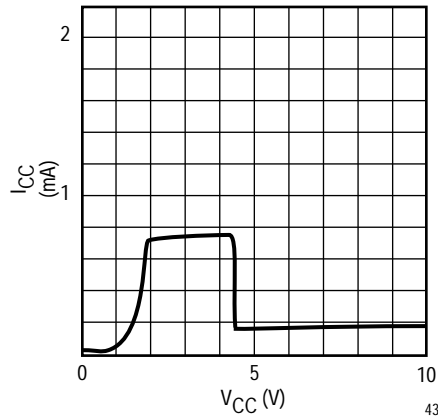

OUTPUT VOLTAGE CHANGE vs. TEMPERATURE

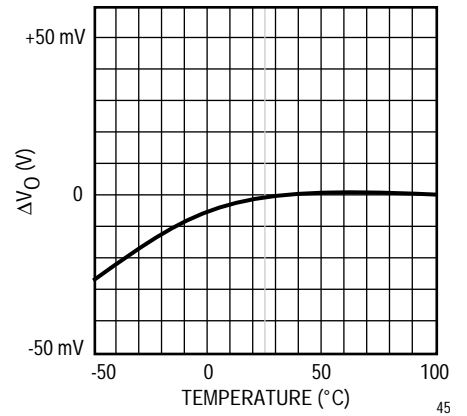

TK11248A

OUTPUT VOLTAGE vs. LOAD CURRENT

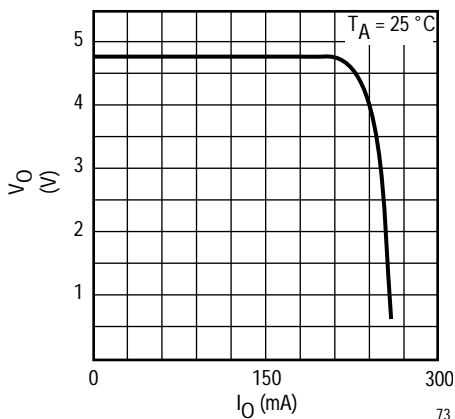

INPUT CURRENT vs. INPUT VOLTAGE (NO LOAD)

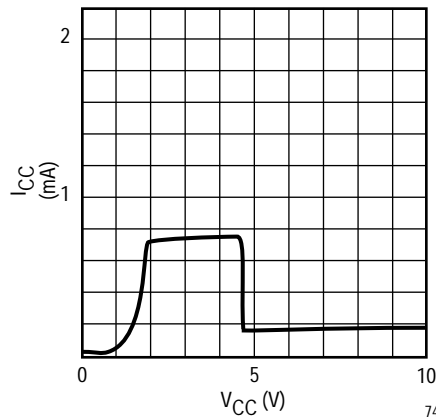

OUTPUT VOLTAGE CHANGE vs. TEMPERATURE

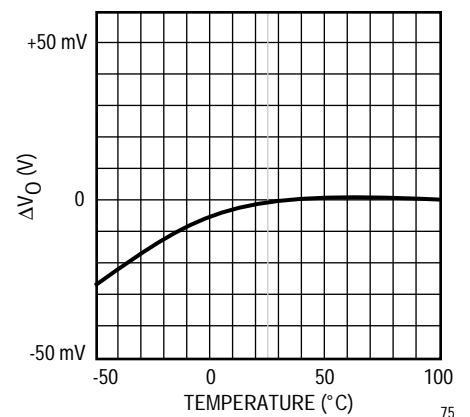

TYPICAL PERFORMANCE CHARACTERISTICS (CONT.)

TK11249A

$T_A = 25^\circ\text{C}$ unless otherwise specified

OUTPUT VOLTAGE vs. LOAD CURRENT

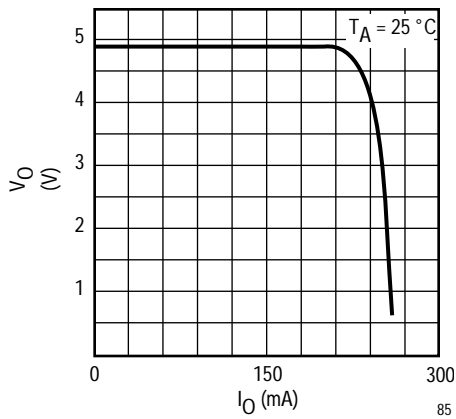

INPUT CURRENT vs. INPUT VOLTAGE (NO LOAD)

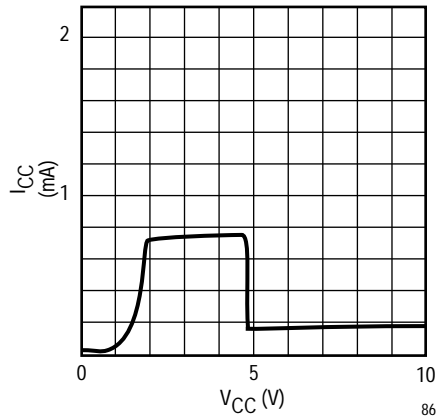

OUTPUT VOLTAGE CHANGE vs. TEMPERATURE

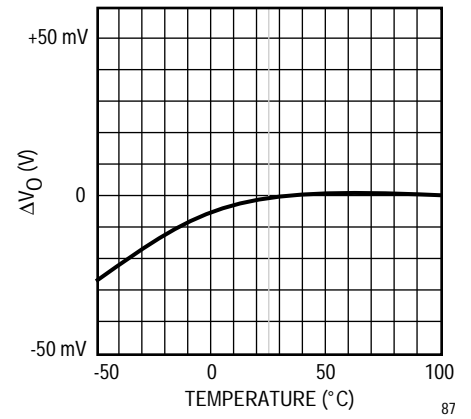

TK11250A

OUTPUT VOLTAGE vs. LOAD CURRENT

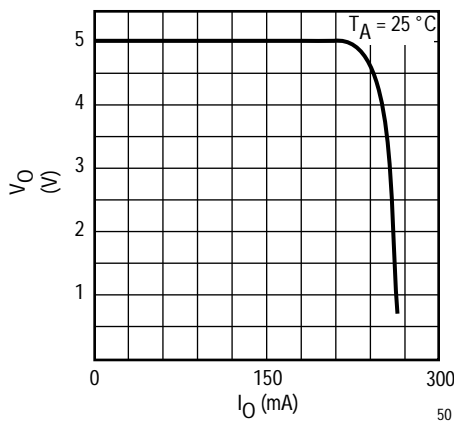

INPUT CURRENT vs. INPUT VOLTAGE (NO LOAD)

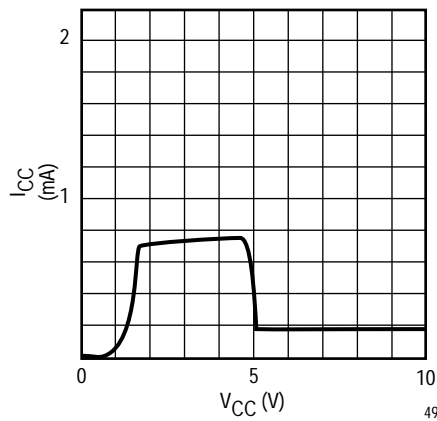

OUTPUT VOLTAGE CHANGE vs. TEMPERATURE

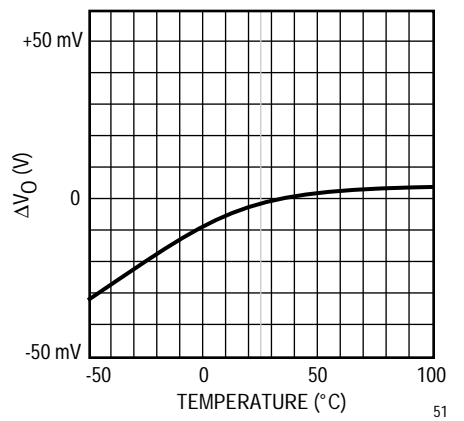

TK11255A

OUTPUT VOLTAGE vs. LOAD CURRENT

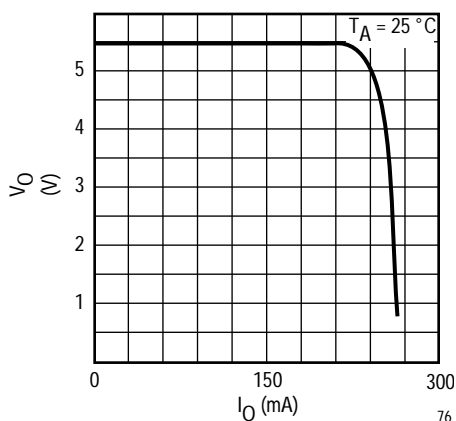

INPUT CURRENT vs. INPUT VOLTAGE (NO LOAD)

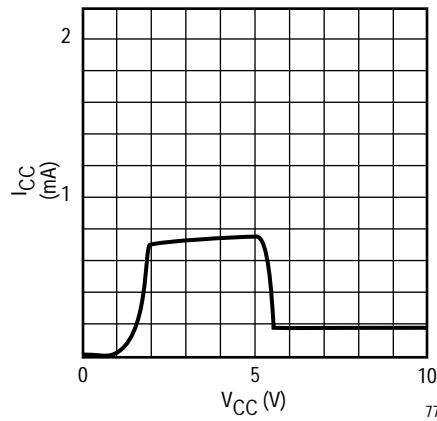

OUTPUT VOLTAGE CHANGE vs. TEMPERATURE

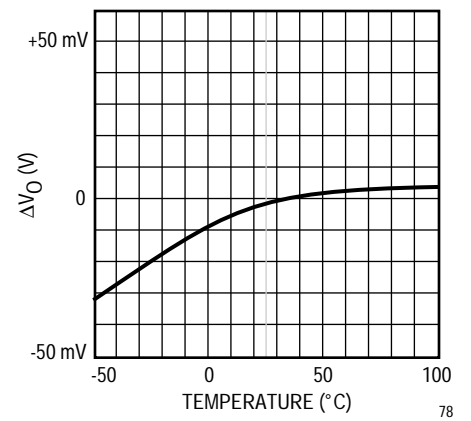

DEFINITION AND EXPLANATION OF TECHNICAL TERMS

LINE REGULATION (LINE REG)

Line regulation is the relationship between change in output voltage due to a change in input voltage.

LOAD REGULATION (LOAD REG)

Load regulation is the relationship between change in output voltage due to a change in load current.

DROP OUT VOLTAGE (V_{DROP})

This is a measure of how well the regulator performs as the input voltage decreases. The smaller the number, the further the input voltage can decrease before regulation problems occur. Nominal output voltage is first measured when $V_{IN} = V_{OUT} + 1$ at a chosen load current. When the output voltage has dropped 100 mV from the nominal, $V_{IN} - V_{OUT}$ is the dropout voltage. This voltage is affected by load current and junction temperature.

OUTPUT NOISE VOLTAGE

This is the effective AC voltage that occurs on the output voltage under the condition where the input noise is low and with a given load, filter capacitor, and frequency range.

THERMAL PROTECTION

This is an internal feature which turns the regulator off when the junction temperature rises above 150 °C. After the regulator turns off, the temperature drops and the regulator output turns back on. Under certain conditions, the output waveform may appear to be an oscillation as the output turns off and on and back again in succession.

PACKAGE POWER DISSIPATION (P_D)

This is the power dissipation level at which the thermal sensor is activated. The IC contains an internal thermal sensor which monitors the junction temperature. When the junction temperature exceeds the monitor threshold of 150 °C, the IC is shutdown. The junction temperature rises as the difference between the input power ($V_{IN} \times I_{IN}$) and the output power ($V_{OUT} \times I_{OUT}$) increases. The rate of temperature rise is greatly affected by the mounting pad configuration on the PCB, the board material, and the ambient temperature. When the IC mounting has good thermal conductivity, the junction temperature will be low even if the power dissipation is great. When mounted on the recommended mounting pad, the power dissipation of

the SOT-23L is increased to 400 mW. For operation at ambient temperatures over 25 °C, the power dissipation of the SOT-23L device should be derated at 3.2 mW/°C. The power dissipation of the SOT-89-5 package is 800 mW when mounted as recommended. Derate the power dissipation at 6.4 mW/°C for operation above 25 °C. To determine the power dissipation for shutdown when mounted, attach the device on the actual PCB and deliberately increase the output current (or raise the input voltage) until the thermal protection circuit is activated. Calculate the power dissipation of the device by subtracting the output power from the input power. These measurements should allow for the ambient temperature of the PCB. The value obtained from $PD/(150\text{ °C} - T_A)$ is the derating factor. The PCB mounting pad should provide maximum thermal conductivity in order to maintain low device temperatures. As a general rule, the lower the temperature, the better the reliability of the device. The Thermal resistance when mounted is expressed as follows:

$$T_J = \theta_{JA} \times P_D + T_A$$

For Toko ICs, the internal limit for junction temperature is 150 °C. If the ambient temperature, T_A is 25 °C, then:

$$150\text{ °C} = \theta_{JA} \times P_D + 25\text{ °C}$$

$$\theta_{JA} \times P_D = 125\text{ °C}$$

$$\theta_{JA} = 125\text{ °C} / P_D$$

P_D is the value when the thermal sensor is activated. A simple way to determine P_D is to calculate $V_{IN} \times I_{IN}$ when the output side is shorted. Input current gradually falls as temperature rises. You should use the value when thermal equilibrium is reached.

The range of currents usable can also be found from the graph below.

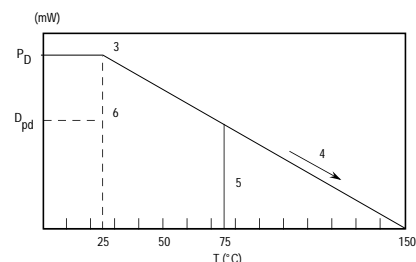

Procedure:

- 1.) Find P_D
- 2.) P_{D1} is taken to be $P_D \times (\approx 0.8 \sim 0.9)$
- 3.) Plot P_{D1} against 25 °C
- 4.) Connect P_{D1} to the point corresponding to the 150 °C with a straight line.

DEFINITION AND EXPLANATION OF TECHNICAL TERMS (CONT.)

- 5.) In design, take a vertical line from the maximum operating temperature (e.g. 75 °C) to the derating curve.
- 6.) Read off the value of P_D against the point at which the vertical line intersects the derating curve. This is taken as the maximum power dissipation, D_{PD} .

The maximum operating current is:

$$I_{OUT} = (D_{PD} / (V_{IN(MAX)} - V_{OUT}))$$

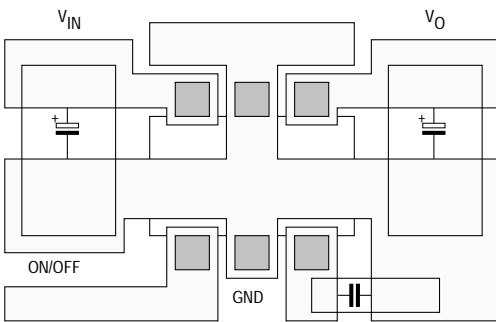

SOT-23L Board Layout

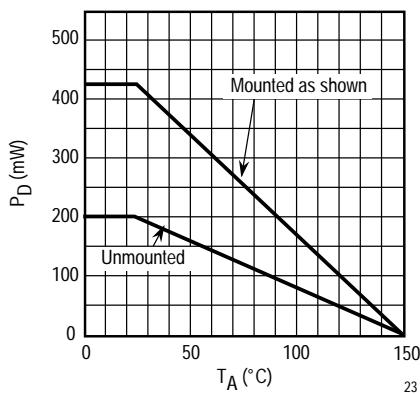

SOT-23L Power Dissipation Curve

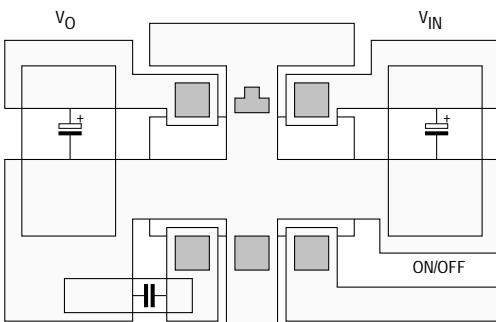

SOT-89-5 Board Layout

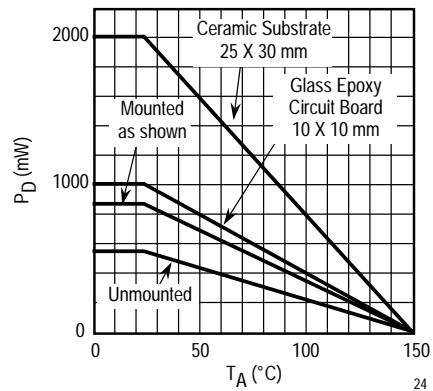

SOT-89-5 Power Dissipation Curve

Copper pattern should be as large as possible. Power dissipation is 400 mW for SOT-23L and 800 mW for SOT-89-5. A low ESR capacitor is recommended. For low temperature operation, select a capacitor with a low ESR at the lowest operating temperature to prevent oscillation, degradation of ripple rejection and increase in noise. The minimum recommended capacitance is 2.2 μ F.

INPUT/OUTPUT DECOUPLING CAPACITOR CONSIDERATIONS

Voltage regulators require input and output decoupling capacitors. The required value of these capacitors vary with application. Capacitors made by different manufacturers can have different characteristics, particularly with regard to high frequencies and equivalent resistance (ESR) over temperature. The type of capacitor is also important. For example, a 4.7 μ F aluminum electrolytic may be required for a certain application. If a tantalum capacitor is used, a lower value of 2.2 μ F would be adequate. It is important to consider the temperature characteristics of the decoupling capacitors. While Toko regulators are designed to operate as low as -40 °C, many capacitors will not operate properly at this temperature. The capacitance of aluminum electrolytic capacitors may decrease to 0 at low temperatures. This may cause oscillation on the output of the regulator since some capacitance is required to guarantee stability. Thus, it is important to consider the characteristics of the capacitor over temperature when selection decoupling capacitors. The ESR is another important parameter. The ESR will increase with temperature but low ESR capacitors are often larger and more costly. In general, Tantalum capacitors offer lower ESR than aluminum electrolytic, but new low ESR aluminum electrolytic

DEFINITION AND EXPLANATION OF TECHNICAL TERMS (CONT.)

capacitors are now available from several manufacturers. Usually a bench test is sufficient to determine the minimum capacitance required for a particular application. After taking thermal characteristics and tolerance into account, the minimum capacitance value should be approximately two times this value. The recommended minimum capacitance for the TK112xxA is 2.2 μF . Please note that linear regulators with a low dropout voltage have high internal loop gains which requires care in guarding against oscillation caused by insufficient decoupling capacitance. The use of high quality decoupling capacitors suited for your application will guarantee proper operation of the circuit.

NOISE BYPASS CAPACITOR SECTION

The noise bypass capacitor (C_p) should be connected as close as possible to pin 3 and ground. The recommended value for C_p is 0.01 μF . The noise bypass terminal has a high impedance and care should be taken if the noise bypass capacitor is not used. This terminal is susceptible to external noise and oscillation can occur when C_p is not used and the solder pad for this pin is made too large.

CONTROL FUNCTION

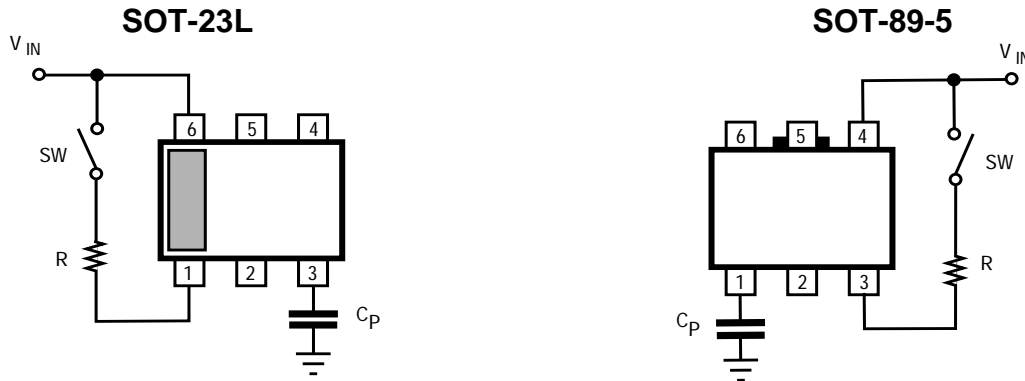

If the control function is not used, connect the control terminal to a logic high level or V_{IN} . This will allow the regulator to be on. The regulator will be on when the control terminal voltage is greater than 1.8 V. The series resistor, R_S , should be less than 300 k Ω . The control current will decrease as R_S increases. The control threshold voltage will also change.

MICROPROCESSOR/LOGIC CONTROL

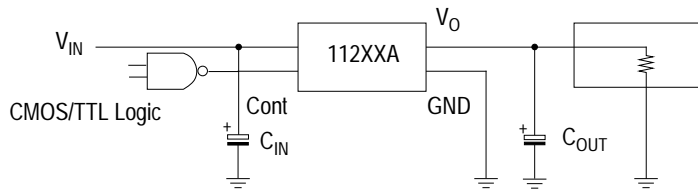

The Input and Control current in the off mode are less than 200 pA.

PARALLEL CONNECTION FOR ON/OFF CONTROL

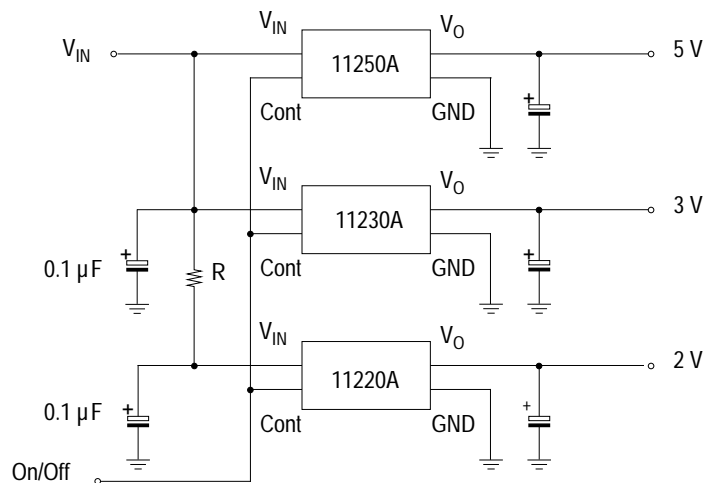

To reduce IC power dissipation, connect a resistor, R_S , in series with V_{IN} for the lower output voltage devices. This will prevent thermal shutdown due to excessive power dissipation.

PACKAGE OUTLINE

SOT-23L

(Pin 2 and pin 5 should be grounded for heat dissipation)

Marking Information

Product Code P

Voltage Code

TK11220A	20
TK11221A	21
TK11222A	22
TK11225A	25
TK11228A	28
TK11229A	29
TK11230A	30
TK11231A	31
TK11233A	33
TK11235A	35
TK11236A	36
TK11238A	38
TK11240A	40
TK11242A	42
TK11245A	45
TK11248A	48
TK11249A	49
TK11250A	50
TK11255A	55

SOT-89-5

Unit:mm

The information furnished by TOKO, Inc. is believed to be accurate and reliable. However, TOKO reserves the right to make changes or improvements in the design, specification or manufacture of its products without further notice. TOKO does not assume any liability arising from the application or use of any product or circuit described herein, nor for any infringements of patents or other rights of third parties which may result from the use of its products. No license is granted by implication or otherwise under any patent or patent rights of TOKO, Inc.



YOUR LOCAL REPRESENTATIVE IS:

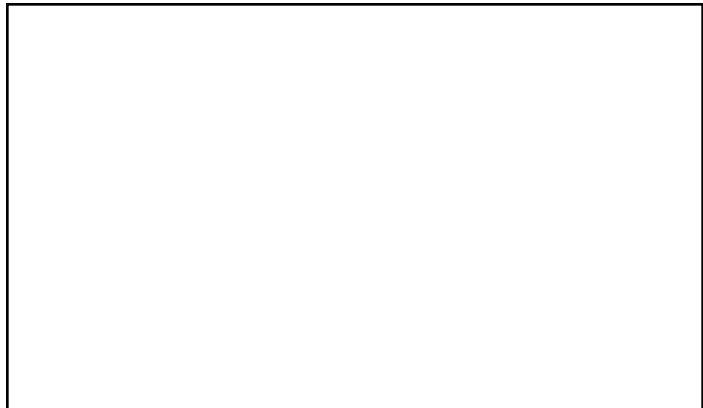

TOKO America
 1250 Feehanville Dr.
 Mt. Prospect, ILL 60056

Tel: 1(800) PIK-TOKO
 Fax: 1(847) 699-1194